 Mensch und Maschine - five years at a glance

All amounts in million EUR (unless stated otherwise)	2001	2002	2003	2004	2005
Revenue	146.8	143.1 -2.5%	131.0 -8.5%	135.5 +3.4%	147.2 +8.7%
Germany	56.6 39%	55.1 38%	48.1 37%	41.5 31%	39.8 27%
International	90.2 61%	88.1 62%	82.9 63%	94.0 69%	107.4 73%
Revenue per share in EUR	16.54	14.19 -14%	12.80 -10%	12.35 -4%	12.21 -1%
Gross Margin	40.0	47.2 +18%	42.5 -10%	42.6 +0.4%	42.2 -0.9%
Trading products	31.6 79%	25.1 53%	21.3 50%	20.2 47%	23.1 55%
M+M Technology + Services	8.5 21%	22.1 47%	21.2 50%	22.4 53%	19.1 45%
Operating result EBITA	7.8	-7.9	-5.0	1.9	10.0 +446%
EBITA return from revenue	5.3%	-5.5%	-3.8%	1.4%	6.8%
Net result	2.3	-14.3	-6.3	-9.2	5.6
Net return from revenue	1.6%	-10.0%	-4.8%	-6.8%	3.8%
Net result per share in EUR	0.27	-1.42	-0.62	-0.85	0.45
Dividend in EUR	0.18	0.00	0.00	0.00	0.10
Total assets	89.2	83.2 -7%	80.1 -4%	69.1 -14%	66.4 -4%
Shareholders' equity	27.8	18.2 -34%	15.2 -16%	9.3 -39%	15.0 +62%
Equity ratio	31.1%	21.9%	19.0%	13.4%	22.5%
Number of shares in million	8.876	10.084 +14%	10.232 +1%	10.972 +7%	12.053 +10%
Number of employees	298	467 +57%	405 -13%	355 -12%	307 -14%
thereof M+M AG	88 29%	89 19%	89 22%	79 22%	72 23%
International subsidiaries	136 46%	141 30%	120 30%	102 29%	95 31%
Technology subsidiaries	74 25%	237 51%	196 48%	174 49%	140 46%

 Events

May 2, 2006	Quarterly report Q1/2006
May 30, 2006	Annual shareholders' meeting
July 31, 2006	Half year report 2006
October 30, 2006	Quarterly report Q3/2006
March 19, 2007	Annual report 2006
March 19, 2007	Analysts' conference

Dear reader,

by achieving new sales and earnings record levels, Mensch und Maschine Software AG (M+M) in 2005 was able to harvest the fruit of a three year restructuring.

A relatively moderate sales increase of almost nine percent lead on to the bottom line, with a net earnings swing of nearly EUR 15 mln to a solid EUR 5.6 mln.

Several drivers interacted to achieve this: Significantly lower operating expenses and lucrative disinvestments lifted the operating result to an all time high, while decreased finance costs and a low tax rate additionally levered net earnings (which had been burdened by impairments in the previous year).

In addition, the balance sheet structure could be brought back to good order. While net bank debt was reduced by 11 million Euro, the capital ratio climbed to a satisfactory level of 22.5 percent.

The financial market reacted to this positive development accordingly. The M+M share price nearly doubled in the course of the year 2005. The shareholders shall profit additionally from the success of the last fiscal year, with a dividend payment amounting to 10 cents per share.

For the fiscal years to come, we aim for a continuation of moderate sales growth, combined with further increasing operating and net returns.

The base for this development is set, as there is significant potential both in the operating margin and the financial result, and the available loss carryforwards provide for a low tax rate.

All in all, these are good prerequisites for a further disproportionate development of the M+M share, to beat the benchmark indexes.

Wessling, March 2006
The Board of Management

2005 at a glance

- Revenue EUR 147.2 mln / +8.7%
 - International share 73% (PY: 69%)
 - Old record mark from 2001 surpassed
- Operating result EBITA on all time high: EUR 10.0 mln / +446%
 - Strictly operating: EUR 3.4 mln / +328%
 - Disinvestment gains: EUR 6.6 mln
- Swing in pretax and net earnings
 - EBT: EUR 7.3 mln (PY: -4.4)
 - Net: EUR 5.6 mln (PY: -9.2)
- Dividend proposal: 10 cents per share
- Net bank debt radically reduced
 - Repayment of EUR 11 mln primarily from disinvestment gains
- Capital ratio 22.5% (PY: 13.4%)
- Balance sheet and financing structure back to the green area

Adi Drotleff
CEO



Michael Endres
Exec VP Marketing



Jens Jansen
CIO



Peter Schützenberger
CFO



Werner Schwenkert
CTO



Management report

Enterprise and market position

Mensch und Maschine Software AG (M+M) is one of the leading European providers of CAD/CAM solutions (Computer Aided Design & Manufacturing).

Well balanced business model

The M+M business model has a relatively broad base within the CAD/CAM market and is equally balanced in three respects:

1. Geographical markets
2. Customers and industry sectors
3. Product portfolio

The distribution over various geographical markets was mainly achieved in the years following the 1997 M+M IPO through a dynamic international expansion.

The good customer and industry sector balance however originated from the early business model, following M+M's foundation in 1984. The product portfolio, which until 1999 had been rather unilaterally focused on Value-Added Distribution (VAD) of standard CAD software from US vendor Autodesk, was evened out during the last two years, mainly by a strong growth push in the business unit "M+M Technologies and Services".

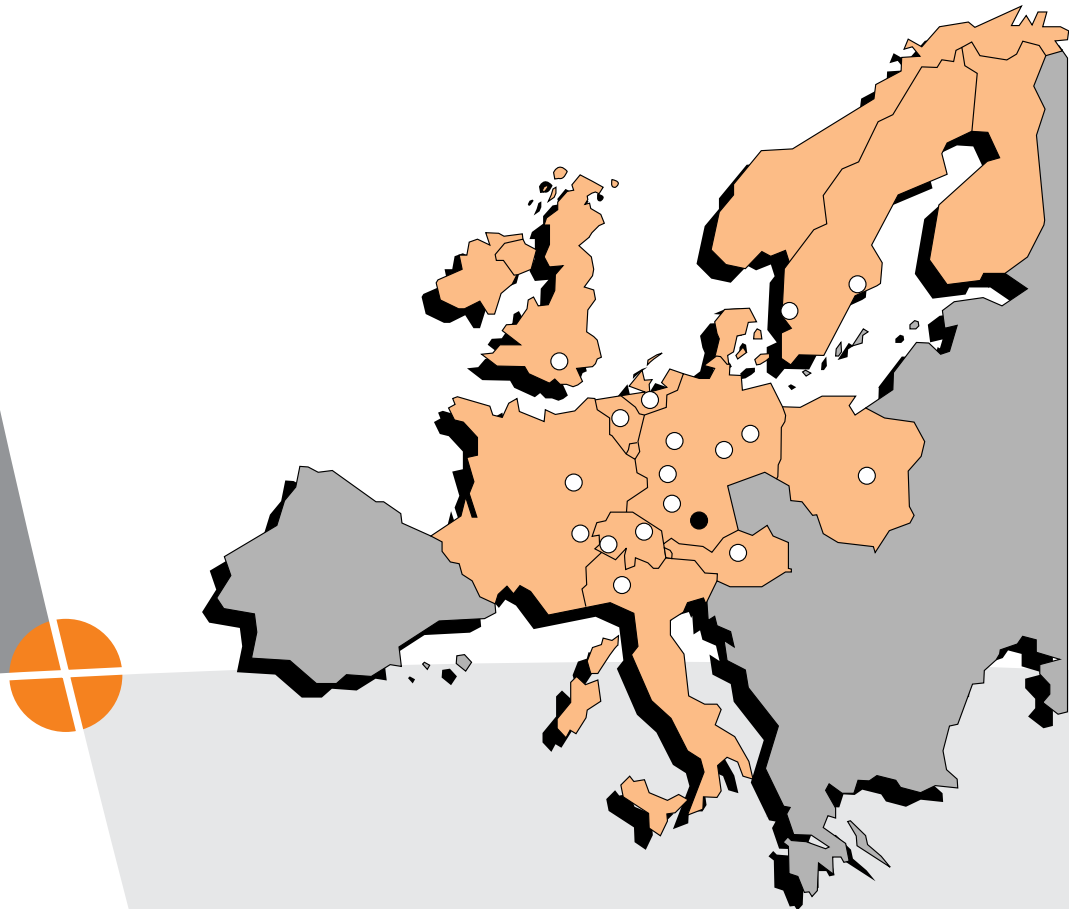

1. Geographical markets

While in 1997 domestic German business was clearly dominant with international sales of only EUR 12.7 mln or 25% of group revenue, the following years saw a multiplication of international business which in fiscal year 2005 amounted to EUR 107.5 mln or 73% of total group sales.

This development was driven by acquisitions in France, Italy, Poland (all 1998), UK, Sweden (2000) and Switzerland (2001) as well as by the foundation of a new subsidiary in Belgium (2002), which today gives M+M market access to 15 European countries. Additionally, there are sales offices in the USA, Japan and Singapore, exclusively marketing M+M Technology.

2. Customers and industry sectors

In this respect, the M+M business is split about half into mechanical engineering and half into the sectors of architecture and the construction industry with building services and visualization (approx. 25%), GIS - Geographic Information Systems / gardening and landscaping (approx. 15%) and electrical engineering (approx. 10%).

This distribution is quite similar to the global CAD market, where about 50% of the total market volume is attributed to mechanical.

Customer and orderwise the distribution of business is even wider. M+M is selling software solutions for about 50,000 CAD/CAM seats per year, mainly through a network of approximately 1,000 authorized resellers, none of whom is achieving more than 3% of M+M group sales. Consequently there are no deep dependencies on the customer side from single purchasers.

Altogether, Mensch und Maschine has built up an installed base of over 500,000 CAD/CAM seats at about 50,000 end customer sites of all size categories - from small engineer's or architect's offices up to international large-scale enterprises.

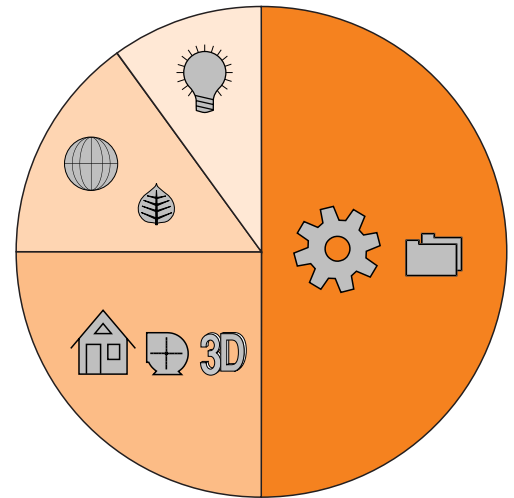

The M+M group's business divides into four industry segments: One half of the sales is achieved with mechanical engineering and PLM (Product Lifecycle Management) solutions. The other half consists of architecture / construction industry (approx. 25%) including building services and visualization, Geographic Information Systems (GIS) / gardening and landscaping (approx. 15%) and the electrical engineering segment contributing approx. 10% of sales.

3. Product portfolio

The M+M product portfolio covers a wide price/performance range from simple drawing software costing a few hundred Euros through midprice 2D/3D design solutions in the four-digit Euro range up to high end systems for manufacturing and production control with software investment costs from 10,000 to 100,000 Euros and more per seat. The majority of CAD sales is generated in the midprice range, while the CAM solutions are sold in the high end range.

Until 1999, only about 10% of the group gross margin was achieved with M+M Technologies and Services, while the VAD business unit was clearly dominant and marked a relatively strong dependence upon main supplier Autodesk.

The M+M Technology gross margin share grew significantly since and amounted to EUR 19.1 mln or 45% of group gross margin in fiscal year 2005. Thus the M+M business model is now balanced across the product portfolio between owned and trading products. This was possible through a Technology Offensive, in the course of which several software developers, fitting to the M+M core business, had been acquired during 2001 and 2002. In most of these companies, M+M already had strategic minority shareholdings. In 2005, one of these companies, COMPASS GmbH, was sold to Autodesk through an asset deal.

Balance between Software Development and Value-Added Distribution

While the VAD segment gives M+M broad market access and contributes over 80% of sales, the self-developed technologies are responsible for the differentiation potential and give the M+M group an individual market profile, clearly distinguishable from its competition.

In the "M+M Technology" segment, M+M is a standard software developer with a gross margin yield of 85% (compared to almost 20% yield in the VAD segment) and concentrates on sector and niche applications which are not covered by the large vendors like Autodesk, PTC or Dassault. The revenue in this segment is generated by the technology and service subsidiaries OPEN MIND, ECS, DATAflor, M+M Akademie, EUKLID and COMPASS (until Feb 28, 2005), and from the product brands RoCAD and CADerschwänglich ("CAD affordable") which are developed by the group mother company, M+M AG.

The M+M product brands

The individual technology subsidiaries and M+M group product brands are introduced as follows.

OPEN MIND Technologies AG

Group member since Q1/2002 (100%)



OPEN MIND specializes on CAM software solutions. CAM stands for Computer Aided Manufacturing. Software solutions from OPEN MIND are used for drilling and milling in various industries like mechanical engineering, tool, mold and die making, automotive and aerospace industry as well as consumer and jewellery manufacturing.

Particularly in the highly complex 5-axis milling process, the hyperMILL product line from OPEN MIND, has a technologically leading position and allows the customers quick payback of their high machine tool investments.

With the patented "cavity milling process", a safe and practical 5-axis solution was developed in a frontrunning position for the wide application area of tool, mold and die making. OPEN MIND offers a variety of innovative applications for specific products like tire molds, turbines and medical technology, in order to enable and simplify the programming of complex handlings, as well as to lower handling time and improve finished quality.

A typical example is the *hyperMILL* solution for the milling of cavities which can reduce the time for design change to delivery of the milled cylinder head, from several days to just a few hours. Ease of use, speed and process security are the reasons why this innovative solution is used by several engine tuners and Formula 1 race teams. Due to the leading edge *hyperMILL* technology, cooperation agreements could be completed with a number of renowned precision machine tool manufacturers.

The OPEN MIND CAM solutions are not only sold in Europe, but also, through subsidiaries, in the USA, Asia/Pacific and Japan. With sales of more than EUR 14 mln, the M+M group belongs in the first tier of vendors in the important niche market of CAM solutions.

*Innovative
CAM strategies
enable high savings
for the design cycle
and machining time:
Milling simulation
of a tire mold using
hyperMILL*

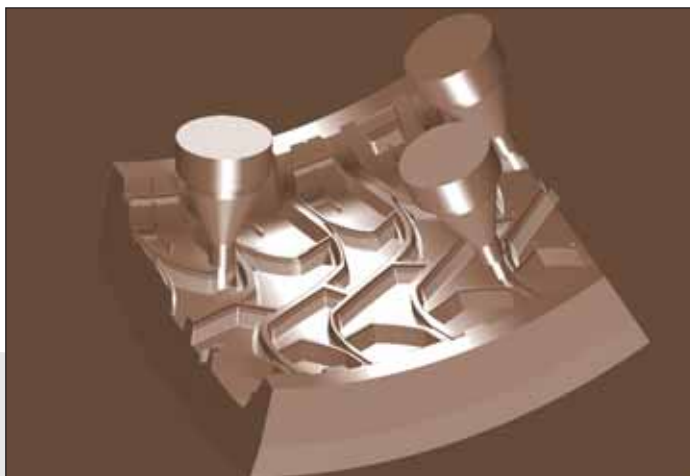

Elektro-CAE Software GmbH (ECS)

Group member since Q1/2002 (60%),
since 1998 minority shareholding



ECS is the developer of ecscad, a leading electrical engineering application in the Autodesk world, being exclusively marketed by the M+M group for over 10 years.

The emphasis in electrical engineering solutions is not in the graphical but in the data base area. Ecscad has its special strength here. Large electrical engineering projects, e.g. at railroad companies, contain up to a thousand or more diagrams which are interlinked by very extensive cross references with each other. These cross references are managed automatically by ecscad in a special database. As a result, the potential for rationalization for such customers is particularly high.

ECS solutions are not only marketed in Europe but are also sold in the USA and in Asia through local distribution and OEM partnerships under the product names Promis-e and RS-Wire.

About 20,000 installations of ecscad and its sister brands are existing in all areas of the mechanical and electrical industry. To address even more customers in the future, new modules are constantly being developed, e.g. for the special requirements of TV studios or the energy supply industry.

DATAflor Software AG

Group member since Q1/2002 (61.5%),
since 1999 minority shareholding



DATAflor has a strong position in the German-speaking gardening and landscaping market for garden and landscape architects as well as garden centers. The proffered solutions not only contain a graphical planning part but also complete financial calculation and billing of such projects. DATAflor was founded back in 1983 and maintains evolved customer relationships which are carefully nurtured.

This has enabled DATAflor, in spite of difficult market economies in the past years, to further enhance their already high market share in this niche market.

RoCAD for building services



The building service solution RoCAD, developed by the mother company M+M AG, holds an important market position in the Autodesk environment, mainly in the German speaking area with about 2,000 installations. RoCAD supplies 2D and 3D solutions for the design and construction of heating, air conditioning, plumbing and electricity. Similar to ecsCAD, the scope of use and customer group potential is constantly extended by development of special modules, e.g. for the calculation of energy and heating requirements.



CADerschwänglich product lines



The CADerschwänglich (CAD affordable) low price product lines have a long inhouse tradition at M+M.

Symbols and parts libraries

From 1988 onwards, M+M has developed symbols and parts libraries, also called "electronic stencils", offering the CAD user lots of standard parts and symbols for very little money. Currently, the collection includes 26,000 symbols and parts, being edited in 11 library packages, which cover a broad sector bandwidth and are used for illustration of documents of any kind, not only in CAD systems but also in Microsoft Office.

At a list price of 60 Euros (+VAT) and over 200,000 copies sold, the libraries are the lowest cost, as well as the highest volume, products made by M+M.

AutoCADmenu and ADT series

Priced above the libraries, there are two other CAD*erschwänglich* product lines. With *AutoCADmenu*, M+M offers low cost user interfaces and applications for 150 to 300 Euros (+VAT), making the daily drafting work easier for mechanical or architectural users as well being compatible with the M+M symbols and parts libraries.



The “ADT” product series, consisting of *Elements*, *Umbau*, *Energy* and *EnEV*, offers the user of Autodesk Architectural Desktop (ADT) supplementary tools for EUR 390 (+VAT) each. *Elements* is a collection of more than 10,000 2D and 3D architectural elements plus approx. 1,000 materials, surface styles and hatching patterns. *Umbau* supports the user particularly for restructuring and renovation projects, while *Energy* and *EnEV* are supporting the room catalogue for technical calculations, e.g. the heat requirements for buildings.

Mensch und Maschine Akademie GmbH

Group member since 1999 (100%),
since 1998 minority shareholding



M+M Akademie is the only pure service subsidiary in the group concentrating on the areas of training and customer-specific software applications. In 2005, software projects for important customers like Deutsche Bahn, Robert Bosch and ABB were executed and approximately 1,000 people have been trained.

EUKLID Software GmbH

Group member since Q2/2001 (100%),
since 2000 minority shareholding

The EUKLID business in the CAD/CAM area has been more and more transferred to OPEN MIND during the past years. In parallel, headcount and expenses were reduced dramatically. In the course of 2004 and 2005, nearly all product lines were sold or sublicensed, removing the former overlap with the OPEN MIND product portfolio.

COMPASS Systems GmbH

Group member since Q2/2002 (50.1%),
since 1999 minority shareholding
Removed from the M+M group as of
Feb 28, 2005 by sale of all assets

COMPASS GmbH held a strong position for PDM/PLM solutions. PDM/PLM means Product Data/Lifecycle Management, i.e. the database management of product-related data throughout the whole design process and product lifecycle.

On February 18, 2005, Autodesk and M+M announced a binding contract concerning the purchase of the entire COMPASS GmbH assets by Autodesk, who also took over all employees including the founders and minority shareholders. With this sale, M+M has realized a cash inflow amounting to EUR 7.1 mln and a book profit amounting to EUR 6.2 mln. Consequently, the COMPASS GmbH business was removed from the M+M group as of Feb 28, 2005.

Strategic minority shareholdings

In addition to the technology subsidiaries, M+M is holding strategic minority shares rounding up the market position in some niche markets.

In the architecture/construction area M+M holds shares in CTB GmbH & Co KG, Buchholz near Hamburg (M+M share 19.9%) and in SOFiSTiK AG, Oberschleissheim/Nuremberg (M+M share 14.3%). CTB and SOFiSTiK are both offering high-quality software solutions for architecture, civil engineering and statics.

In the GIS field there was a 20% shareholding in C-Plan AG, Muri near Berne, Switzerland. C-Plan develops complete solutions for local governments and energy suppliers and is successfully selling them in Switzerland and Germany, as well as increasingly in other European countries. C-Plan AG was acquired by Autodesk in Q2/2005. M+M has realized a cash inflow amounting to EUR 3.2 mln and a book profit amounting to EUR 2.1 mln for its share.

Further shares are held in YELLO! AG, Wiesbaden (M+M share 29.3%), acting in the visualization and animation area, and in CYCO BV, Netherlands (M+M share 7.4%), a supplier of EDM (Electronic Document Management) solutions.



Large target market CAD software and service

The worldwide market for CAD software and service has an annual sales volume of about EUR 10 billion (Sources: Daratech, Dressler-Verlag, own) and is segmented into mechanical engineering, PLM, architectural/construction, geography, electrical engineering, electronic and structural analysis. Except for the latter two, M+M covers all of the segments.

The volume of M+M's main market, Europe, thus is just over 3 bln EUR, meaning that M+M reaches a direct market share of 4-5%. The indirect market share, equal to the revenue volume of the M+M reseller network in the market, is in the range of 10%, because the resellers' sales multiple is estimated to be in the order of magnitude of 2 to 2.5.

Protecting and expanding the market position

Totalling EUR 25.2 mln in 2005, sales and marketing continued to hold the largest share (63%) in group operating expenses. This sum contains a marketing budget amounting to EUR 6.7 mln, primarily used for advertisements, trade shows and other marketing activities to protect and expand M+M's market position.

Marketing budget concurrently optimized

The marketing area is continuously optimized in order to reach as many potential customers as possible with the funds spent. The trend for trade shows has been to be present at more shows whilst using a lower budget per stand (in 2005 M+M attended 58 shows in 12 countries). As an indirect vendor, M+M is attending trade shows usually partnering suitable resellers. Like all marketing activities offered by M+M, the resellers' trade show expenses are settled via the "PR-Pool", a revenue-driven marketing fund for authorized M+M partners.

M+M Magazine reaching 200,000 customers

Through a carefully maintained address database, the customer newspaper "M+M Magazine" reaches about 200,000 existing and potential customers. In 2005, altogether 8 issues in four languages were published with a total number of 88,000 copies. More and more, web publishing of the magazine issues plays the main role in reaching customers and prospects, saving considerable printing and mailing expenses.



High focus on address qualification and CRM

Nothing is more wasteful than trawling through unqualified or duplicated addresses. A CRM system (Customer Relationship Management) and focused use of tele-marketing activities are used for actuality and compactness of the address database. As well, an efficient and timely distribution of prospects' leads within the M+M reseller network is essential - including tough control of the resellers' performance to make sure that requests from end users are answered quickly and to the best standard possible.

Strong focus on IT and backoffice

A prerequisite for the efficient use of marketing funds, as well as for a well-functioning supply chain, is an optimized IT and backoffice system.

SAP R/3 and integrated CRM system

Since 1997, M+M has used the ERP system SAP R/3, which in the meantime has been introduced in nearly all group companies and was updated to the most recent version of mySAP ERP at the end of 2005. Building on this, a web-based CRM system, fully integrated in SAP, was introduced and adapted to the various sales and marketing tasks of the group during the past years.

More than 60% of orders through web shop

Along with the growing integration of the individual components, the processes could be optimized. e.g. more than 60% of all orders are coming in electronically through the internet, because customers can use web shops for comfortable ordering round the clock. There is a closed shop for authorized resellers, fully integrated in mySAP ERP, and an open shop for end customers in the low-price sector (*CADerschwänglich*). Additionally, resellers can lease a shop via "shop hosting" from M+M, enabling them to present their product and service portfolio under their own corporate identity and transfer the appropriate part of the incoming orders to M+M at a fingertip.

Integration with suppliers and customers ...

The mid range goal in the IT/backoffice area is the full integration of the supply chain in order to further save processing costs and eliminate error sources. This requires an electronic interface not only on the customer but also on the supplier side (Supply Chain Management - SCM). The main supplier Autodesk was already interfaced as far as possible.

... drives up electronic order entry quota

This allows the electronic order entry quota to further accelerate towards 100%, opening high cost saving potentials for M+M as well as for customers and suppliers.

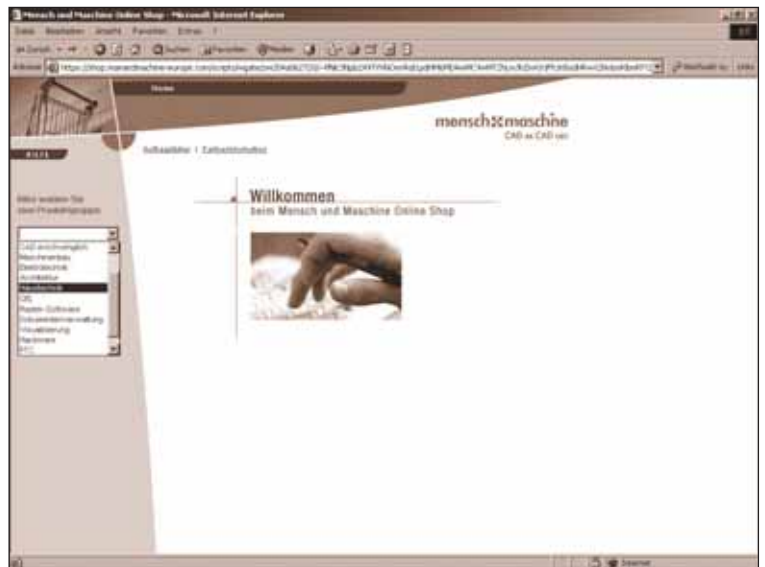

High ongoing development investments ...

With a total amount of EUR 6.3 mln or 16% of operating expenses in 2005 (equaling 37% of segment operating expenses), research and development again represented a significant cost position in the M+M group. These funds were used for the maintenance and development of M+M software products.

... are not capitalized:

software library is a hidden reserve

Capitalization of development costs according to IAS 38.45 is not applied by M+M, meaning that the extensive software basis of the group containing hundreds of man years of invested development power represents a hidden reserve.

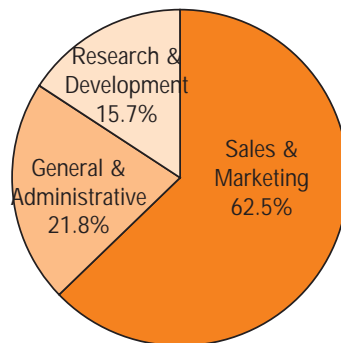

The distribution of operating expenses in the M+M group shows a clear dominance of sales and marketing expenses

Employees are co-entrepreneurs

Traditionally, there is a very high focus on good corporate culture at M+M. During the 22 years since foundation of the company in 1984, the employees were always seen as "Co-Entrepreneurs" and fully integrated in the decision making process. Whenever acquiring companies in and outside Germany in the course of the intensive expansion since IPO in 1997, M+M always cared for and respected the specific culture of the companies acquired and encouraged them to adopt M+M corporate culture very gently. The decision making structures in the M+M group are as decentral as possible, the individual entities have a high degree of autonomy in order to achieve the best possible results in the individual markets and to be able to optimally meet the customers' requirements.

Experienced management team

This corporate culture generates a high degree of continuity. Fluctuation in the M+M group is very low, which especially during the hype phase of the IT industry at the end of the 90's prevented a drain of qualified specialists from which other similar companies in IT suffered. As a result, M+M has an experienced management team down to the second and third management level, with team members mostly looking back on an employment period of more than 10 years.

Public and private company

Though M+M shares have been listed on the stock market for eight years, a large part of the shares are still in the hands of the management board. Founder and CEO Adi Drotleff holds approximately 5.2 million shares or 42.9% of the approximately 12.1 million shares outstanding at Dec 31, 2005. A package of 824,000 shares (6.8%) is owned by CTO Werner Schwenkert. This was created from the acquisition of OPEN MIND AG by the M+M group through a share swap.

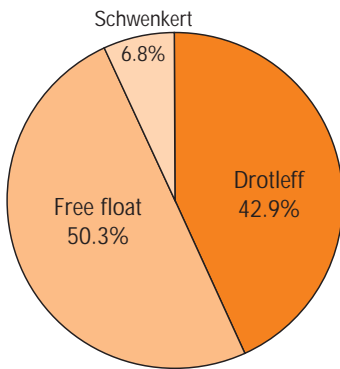

The free float at Dec 31, 2005, contained about 6.1 million shares or 50.3%. A certain part thereof was held in smaller packages by other members of the management board or the next management levels. M+M thus can be seen as a public and a private company in one. This is also documented in the acceptance of responsibility for the company by the share-owning officers who are guaranteeing bank credits of the group. Adi Drotleff additionally granted M+M AG an interest-free loan and signed a part of the 2004 convertible loan, in order to strengthen the financial power of the group.

At December 30, 2004, KTB Technologie Beteiligungsgesellschaft mbh & Co KG subscribed a package of almost 1.0 million shares (8,2%) from a capital increase. Due to the good performance of the share, 0.6 million of these shares were sold to other institutional investors in the course of 2005, leading to a reduction of KTB's voting rights share in Mensch und Maschine Software AG under the 5% limit as of Dec 31, 2005. Thus, the KTB share is counted to the free float.

Course of business 2005 and situation of the group

In fiscal year 2005, the M+M group achieved new record levels for sales and earnings. With accelerating sales growth and a high earnings swing, a three year restructuring phase could be completed positively.

Additionally, debt was significantly lowered and the balance sheet structure improved by two lucrative disinvestments.

Accelerating growth and new sales record

Sales amounted to EUR 147.2 mln (PY: 135.5 / +9%), surpassing the former record mark from fiscal year 2001. Adjusted by the COMPASS disinvestment, sales increased by 11 percent.

Including the 2002 and 2003 consolidation, the continued annual growth rate (CAGR) since the floatation in 1997 still averaged a remarkable 14 percent. The international share of revenue once more climbed to 73% after 69% in the previous year.

The strong revenue development since floatation is also significantly visible on a per share basis: Revenue per share climbed from EUR 6.67 in 1997 to EUR 12.21 in 2005 - an indication of the growth of inner value.

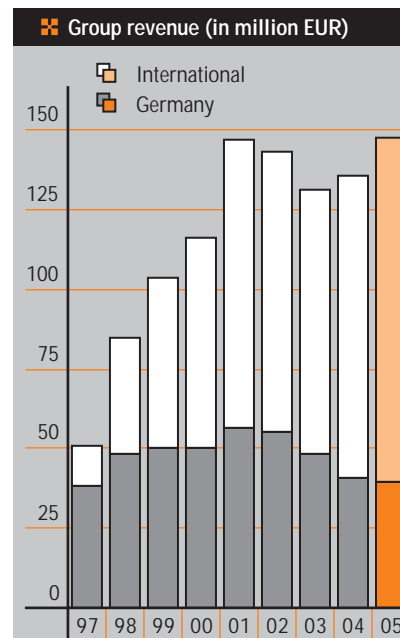

Quarterly seasonality

more balanced than in the previous year

Quarterly sales seasonality in 2005 was significantly more balanced than in the previous year. Although the final quarter, as always, had the highest sales amounting to EUR 38.9 mln (PY: 38.2 / +2%), the difference to the lowest quarter Q2 with sales of EUR 33.7 mln (PY: 30.3 / +11%) was much less than usual.

With sales amounting to EUR 75.0 mln (PY: 67.5 / +11%), the second half year showed significantly higher growth than the first six months with sales of EUR 72.2 mln (PY: 68.0 / +6%). Adjusted by the COMPASS disinvestment, the development was even more dynamic, as the COMPASS business was fully consolidated by Feb 28, 2005, and thus contributed pro rata to the first six month's sales. The adjusted growth in the second half year was approximately 14 percent compared to 7 percent in the first half.

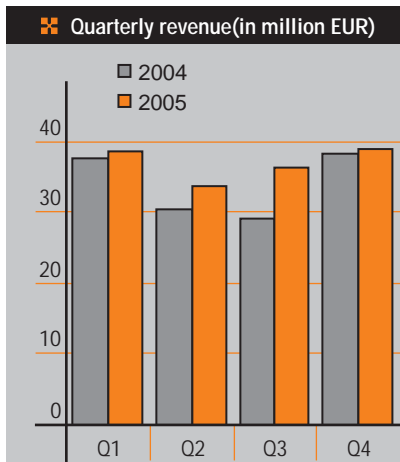

Gross margin balanced

between distribution and own technology

After deduction of purchased goods (VAD) or cost of production (M+M Technology), gross margin was nearly unchanged amounting to EUR 42.25 mln (PY: 42.64). The disinvestment had more impact on gross margin than to sales, as COMPASS was a software development company with a high gross

yield. Adjusted by the disinvestment, group gross margin increased by approximately two million Euro or 4 to 5 percent.

In addition, the disinvestment should be taken into consideration for the segmentation. The share from M+M technology and service fell from 53% to 45% compared to last year. This change is composed from an increase to EUR 23.12 mln (PY: 20.22 / +14%) in gross margin generated by the trading product segment (VAD) and a decrease to EUR 19.13 mln (PY: 22.42 / -15%) in the M+M technology segment, mainly caused by the COMPASS disinvestment.

In spite of the relative decrease, the balance between own and traded software in gross margin is still intact. We also do not expect significant changes for this balance between the segments in the years to come.

Future concentration on M+M technology and Autodesk

In order to guarantee the steady growth necessary for this balance, the PTC business, which had been slipping in recent periods, will be discontinued from April 1, 2006, with the capacity made available by this step being refocused to the growth and value drivers Autodesk business and M+M Software.

Headcount further reduced significantly

The number of employees, which had jumped from 298 to 467 between 2001 and 2002 in the course of the technology offensive and reduced in the following two years to 355 on a 2004 yearly average through synergy and restructuring programs, decreased by another 14% to 307 on a 2005 yearly average. This reduction was caused half each by the COMPASS disinvestment and by the restructuring.

46% of the 307 employees in the M+M group worked for technology subsidiaries, 31% for international subsidiaries in the VAD business unit and 23% for the mother company, covering the VAD segment in Germany and group holding functions.

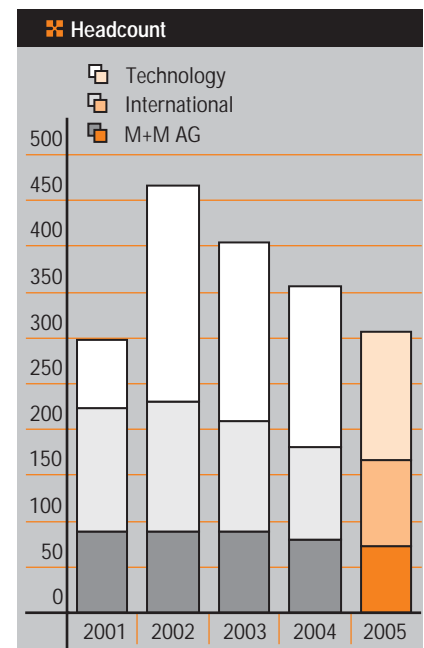

Restructuring fully completed

Altogether, employment was reduced by 177 heads or 37% in three years since April 1, 2002, when after the first time consolidation of all new subsidiaries in the course of the technology offensive, a maximum of 484 employees had been reached. The total amount invested in the restructuring was EUR 7.7 mln (distributed to EUR 1.9 mln in 2002, EUR 2.2 mln in 2003, EUR 1.9 mln in 2004 and EUR 1.7 mln in 2005).

Sales per head grew 57% in 3 years

The significant headcount reduction, combined with an increase in business volume, resulted in sales per head growing 57% from KEUR 306 in 2002 to KEUR 480 in fiscal year 2005.

Operating expense base significantly reduced

The operating expenses developed approximately in line with headcount. At first, the technology offensive caused a strong cost push with operating expenses including depreciation of fixed assets climbing from EUR 33.3 mln in 2001 to EUR 50.6 mln in 2002. The positive effects of synergy and the restructuring programme caused a reduction by 8% to EUR 46.7 mln in 2003 and by 7% to EUR 43.4 mln in 2004.

Due to delayed effects and the COMPASS disinvestment, the 2005 operating expenses fell by another 7% to EUR 40.3 mln.

The operating expenses include an increase of accruals in the group by EUR 0.5 mln and fictitious personnel expenses amounting to EUR 0.1 mln from the first time application of the IFRS 2 rules (share based payments) for issuing share options to employees.

Other operating income (excluding non-recurring effects) developed in line with operating expenses and decreased by 8% to EUR 1.44 mln (PY: 1.56).



Significant jump in operating profit

The operating result EBITA before interest, taxes, goodwill amortisation/impairment and non-recurring effects jumped to EUR 3.43 mln (PY: 0.80). EBITA contains depreciation of fixed assets amounting to EUR 0.88 mln (PY: 1.36), thus the operating result EBITDA before depreciation, amortization and non-recurring effects amounted to EUR 4.31 mln (PY: 2.16).

Trading product segment back to profitability

The predominant part of the operating profit improvement was contributed by the trading product segment: Here EBITA before non-recurring effects developed from EUR -1.82 mln in the previous year to EUR 0.75 mln, being back to profitability after three negative years. The achieved return from revenue amounting to +0.6% (PY: -1.7%) is still very open to development, the long term target in this trading segment with its 15-20% gross yield should be 4-5%.

M+M technology with satisfying return from revenue

In spite of the COMPASS disinvestment, the M+M technology segment contributed to EBITA, before non-recurring effects, an unchanged EUR 2.68 mln (PY: 2.67), improving return from revenue from 10.0% in the previous year to 12.2%. Though this is already an acceptable level, we are convinced that it can be further developed. The long term goal in this segment, where M+M is comparable to a standard software company, is in the 20-25% range.

High positive balance from disinvestments and restructuring expenses

The book profits from the COMPASS and C-Plan disinvestments totaling EUR 8.29 mln play a dominant role in the 2005 Financial Statements. In the previous year, there were positive non-recurring effects amounting to EUR 2.94 mln. Together with restructuring expenses amounting to EUR 1.69 mln (PY: 1.91), the resulting balance of non-recurring effects is EUR 6.60 mln (PY: 1.03).

Operating profit after non-recurring effects reached record level

The operating profit EBITA after non-recurring effects reached a new company record level at an amount of EUR 10.03 mln (PY: 1.84). Compared to the EUR -7.9 mln amount in the crisis year 2002, an improvement by approximately 18 million Euro was reached in three years. The operating result EBITDA before all depreciations and amortizations amounted to EUR 10.91 mln (PY: 3.20).

After an EUR 0.30 mln (PY: 3.00) impairment, the operating result EBIT after all depreciations, impairments and non-recurring effects was EUR 9.73 mln (PY: -1.16).

Financial result profits from lower debt

Due to the debt repayment, the financial result, which had marked a negative record in 2004 at an amount of EUR -3.28 mln, developed positively to EUR -2.40 mln.

Dynamic swing in pretax and net result

This resulted in an improvement of pretax and net result even more dynamic than for the operating profit: Earnings before tax came in at EUR 7.33 mln (PY: -4.45), net result was EUR 5.56 mln (PY: -9.22).

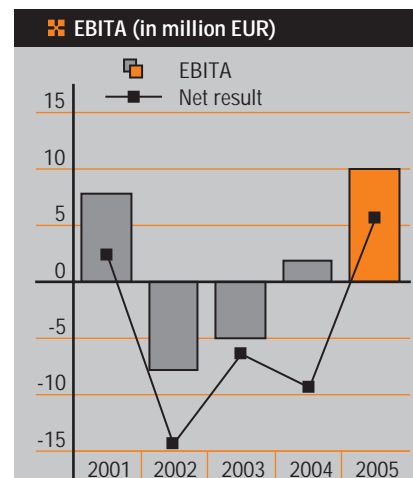

The aftertax result in the previous year was significantly impacted by an impairment of tax assets in the amount of EUR 4.57 mln. Therefore the booked tax load for 2004 was EUR 4.77 mln, while for 2005 the tax load amounted to EUR 1.77 mln, split up by tax payments of EUR 1.92 mln and a small tax asset increase amounting to EUR 0.14 mln. Depreciation of tax assets was not applicable because the impairment in the previous year created a hidden reserve, leading to a relatively low group tax rate in the case of normal course of business for several fiscal years to come, due to use of tax carryovers.

**Dividend payment
of 10 cents per share suggested**

Undiluted earnings per share in 2005 were EUR 0.45 (PY: -0.85). This allows, after a three year break, to propose a dividend payment of 10 cents per share.

**Expansion strategy until 2002
with high investments ...**

The M+M group has invested heavily in the years since 1998. Investments were made first for international expansion, pushing M+M into the group of leading CAD vendors in Europe, and second, in the course of the Technology Offensive, balancing the product portfolio across trading products and M+M technology. The peak of investment activities was passed in the year 2000, when cash investments amounting to EUR 13.9 mln were made. In the two following years, cash investments totalled significantly lower: 2001 at EUR 5.8 mln and 2002 at EUR 6.9 mln.

... financed using equity and debt

The financing of this expansion was done first by use of equity and from 2000 onwards by use of bank credits available in sufficient volume and at favourable conditions. This expansion policy lead to a balance sheet structure with an excess on the debt side.



Only moderate investments since 2003

After completion of the technology offensive the investments were reduced to those amounts necessary to keep the fixed assets on an actual status. These amounts were EUR 0.93 mln in 2003, EUR 0.47 mln in 2004 and EUR 0.30 mln in 2005. Also for the years to come, only investments in the order of magnitude of EUR 0.5 mln are necessary, because in the M+M business model the main future investment is in the area of software development, the expenses for which are not capitalized.

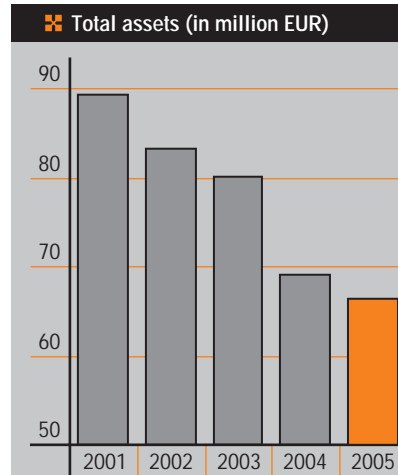

Total assets further decreased

Total assets in the group have decreased significantly since the all time high in 2001 amounting to EUR 89.2 mln in the course of past years, being down to EUR 66.4 mln (PY: 69.1 / -4%) as of Dec 31, 2005, which is about one quarter below the 2001 level. Drivers for this development were balance sheet cleanups and disinvestments, as well as a reduction of the value bound in current assets.

In spite of the expansion of business volume in 2005, inventories could be held at a nearly constant low level of EUR 5.1 mln (PY: 4.5), and accounts receivable was reduced to EUR 23.5 mln (PY: 25.0).

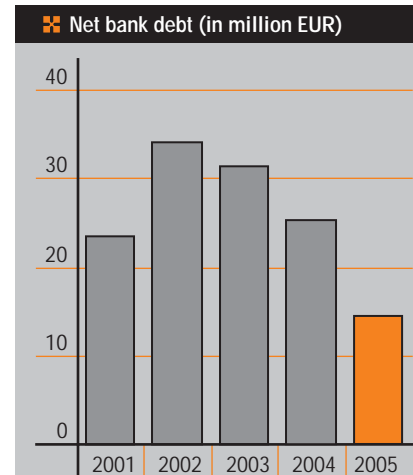

Net bank debt radically reduced

Net bank debt, defined as current plus non-current bank debt minus cash, could be reduced through the cash created from the disinvestments to EUR 14.4 mln as of Dec 31, 2005, being EUR 11.0 mln or 43% below previous year's amount of EUR 25.4 mln. Compared with the historical high of EUR 37.2 mln reached at Sep 30, 2002, net debt was driven down by nearly 23 million Euro or 61%.

Capital ratio significantly recovered

Shareholders' equity according to IAS/IFRS in the group as of Dec 31, 2005 recovered to EUR 15.0 mln (PY: 9.3 / +62%), the capital ratio amounted to 22.5% (PY: 13.4%).

In addition to a positive net result, two more parameters contributed to this improvement. Firstly, due to the good price performance of the M+M share, approximately 75,800 employee share options were exercised in the course of 2005, resulting in a cash inflow amounting to EUR 0,2 mln to equity. Secondly, fictitious personnel expenses according to IFRS 2 from the granting of share options to employees increased capital reserve by EUR 0.1 mln.

Shareholders' equity in the financial statements of the mother company M+M AG set up in accordance to German accounting standard HGB amounted to EUR 17.2 mln (PY: 15.3), with a capital ratio of 34.3% (PY: 28.0%).

Financing structure back to the green area

All in all, after achieving the debt repayment goal, the financing structure on group level is back to a satisfactory level, as far as the balance between equity and debt is concerned. In the course of 2006, further optimization will be conducted to the intra-group structure of bank debt, in order to improve allocation of bank credits to individual group members and to further lower the interest rate payable.

Risks

The operations and activities of the M+M group are subject to various risks. The risk management is controlled directly at board level by monitoring risk relevant parameters from the individual group segments and by comparison with the internal targets, to allow for a timely reaction in case of changes within the enterprise or in the enterprise's environment.

Our monitoring system is constantly optimized to maintain an appropriate standard.

In detail, the following risk categories exist:

Credit risks:

Bad debt risks are counteracted with customer credit insurance, individual bad debt provisions, and streamlined receivables management.

Also favourable in this respect, is the fact that sales are divided among many individual customers each of which carries less than 3% of the total revenue.

Warehouse and transport risks:

These risks are generally covered by corresponding insurance contracts.

A risk of loss in value during warehousing can be considered virtually non-existent since the suppliers' software product contracts always comprise a price, update and stock rotation clause.

Sales and market risks:

As with every other supplier of standard software, M+M is subject to software market and product cycles, especially those of the CAD market. Such risks are generally counteracted, as far as possible, by the vertical and regional division of the M+M Group as well as by the spread across several product lines, but risk may not always be fully compensated by these actions.

Personnel risks:

As an enterprise in the software industry, M+M is, in principle, dependent on individuals with special skills. M+M's distinctive corporate culture, so far, has been instrumental in keeping employee turnover exceptionally low. The risk of dependence upon key top management people has been counteracted by appointing several individuals to the management board and by strengthening the secondary management level.

Supplier risks:

Concentration on the main supplier Autodesk represents a certain risk through dependency on this supplier's product development, market competence and operational policy.

Losses at subsidiaries and shareholdings:

In all shareholding or subsidiary relationships, it is recognised that there is a risk that, contrary to positive expectations, a negative development may occur possibly proceeding to total loss. This would not only cause an appropriate depreciation of goodwill or investment value but also lead to a corresponding writedown of deferred tax assets in case of fully consolidated subsidiaries with loss carryovers.

Financing and liquidity risk:

As in any business model not exclusively financed by equity, there is a dependency risk for the debt financed part due to the refinancing capabilities of the financial market. This risk is counteracted by distribution of credit lines at several banks inside and outside Germany. It cannot be excluded, however, that the refinancing interest rate payable by M+M may develop negatively or the refinancing by debt may fail in parts or in total. In this respect, internal as well as external influences play a roll. Internal influences are mainly the earnings and financial status impacting the M+M market rating, as well as the management's ability in handling relationships with existing and potential creditors. External influences are for example the general interest rate level on the market, the credit policy of banks and other creditors, as well as the legal framework conditions like the Basel-II-Guidelines being intensively discussed.

Conversion to 'European SE' planned

Along with the conversion to a pure holding structure by spinning off the German operating business from the mother company to a subsidiary, which has been planned for a long time, the Management will propose on the annual shareholders' meeting at May 30, 2006 the conversion to a "Societas Europaea" retro-active as of Jan 1, 2006.

Mensch und Maschine is sort of a prototype for the SE with companies in seven EU states and an international sales share of more than 70%. An additional argument is the possibility which so far has not been available under German Stock Corporation Law, to implement a board structure where the chairman of both Management and Advisory board is united in one person. We think that this 'monistic' management structure is better suited for an entrepreneurial public company like M+M, in which executive board members are holding a majority at the shareholders' meeting, than the classical dualistic system with strictly separated Advisory and Management Boards designed for public companies with a broad free float.

M+M is combining the step to the SE with a streamlining of the management structure from nine people – three advisory board members, six management board members – to just a total of seven people. Beside the founder and major shareholder Adi Drotleff as the chairman, two members from the existing Advisory Board will stay on as members of the new Administrative Board. On the Management Board, equalling the 'Vorstand' of a German AG, Drotleff plus the existing members Werner Schwenkert (Technology), Peter Schuetzenberger (Finance), Michael Endres (Marketing) and Jens Jansen (IT), will be appointed.

Outlook

After the successful completion of the turnaround, our mid term strategy is to continue the moderate sales growth of approximately 10% per year, with focus on increasing profit margin. We deem this possible, because the M+M business model is very slim after a three year restructuring, containing efficiency reserves for the years to come.

Target 2006: Doubling operating profit

For the current fiscal year 2006 the management is expecting around ten percent sales growth to revenues exceeding EUR 160 mln. The EBITA return rate, which in 2005 (strictly

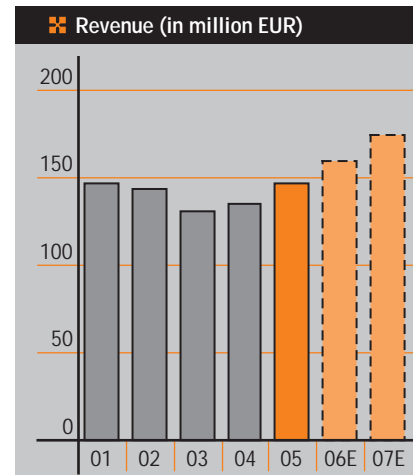

operating, excluding non-recurring effects) was 2.3%, shall be roughly doubled, resulting in a target range for operating profit EBITA between EUR 6.5 and 8.0 mln.

Along with a positive trend in the financial result from debt reduction and a low tax rate due to high loss carryovers, net earnings are estimated to be in the range of EUR 4.5 to 6.0 mln or EUR 0.37 to 0.50 per share.

In case of the achievement of the above goals, a dividend payment increase to EUR 0.15 per share is targeted. This still would allow for retaining more than half of the net profit for further improvement of the company's balance sheet structure.

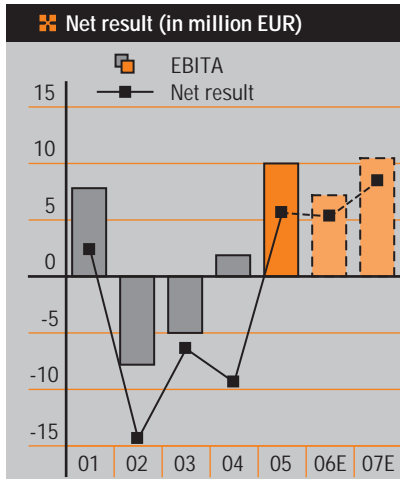

Thanks to employees and shareholders

The management team would like to take the opportunity to thank all employees for their great engagement during the past fiscal year, which contributed significantly to the return on the growth path and into the black.

In addition, we would like to express our thanks to our shareholders for their loyalty towards Mensch und Maschine Software AG or for newly investing in the M+M share.

Wessling, March 2006
 Mensch und Maschine Software AG
 The Board of Management

Target 2007:

EBITA return rate above 5 percent

Also for the following fiscal year 2007, sales are targeted to increase approx. 10% to a minimum EUR 175 mln. The EBITA return rate is intended to be improved to a 5% to 7% range, resulting in an operating profit from EUR 9 to 12 mln and net earnings from EUR 7.0 to 9.5 mln (approx. 0.60 to 0.80 per share). The dividend in case of achievement of these goal is intended to amount to EUR 0.20 per share.

All estimates subject to error

All forward looking statements made herein are subject to market conditions occurring in line with estimations in the planning models set up by the management. Therefore no guarantee can be undertaken for meeting the estimates.

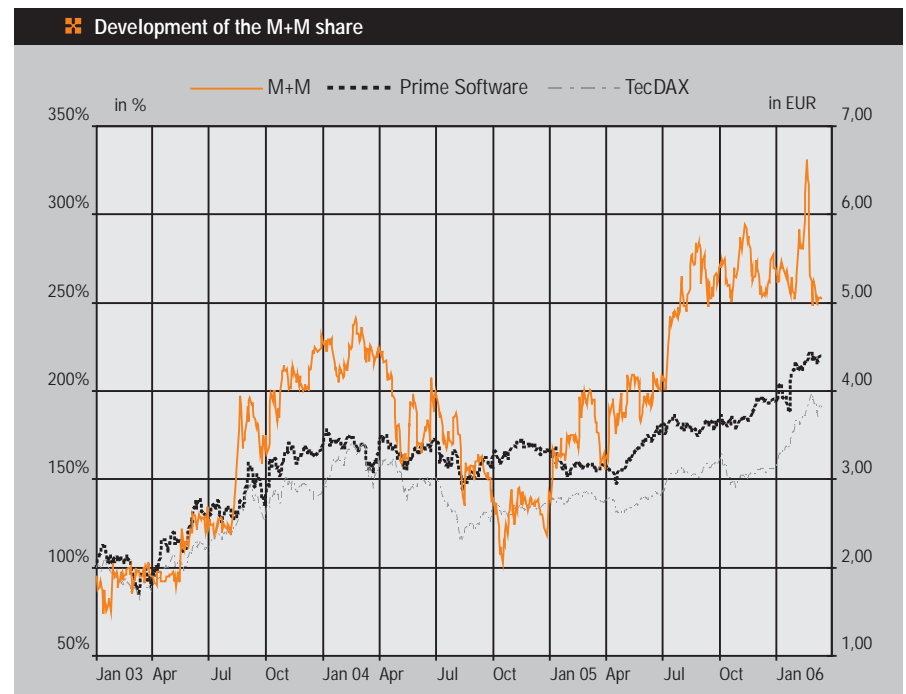

The M+M share has nearly tripled price since the beginning of 2003, outperforming the comparative indexes TecDAX and Prime Software

❏ CAD in practice

Electrical Engineering with ecscad

Project: Renovation of the Linz-Center district heating power station

Customer: Linz Strom GmbH, member of Linz AG group, Austria

After extension and renovation, the Linz-Center district heating power station is one of the most modern facilities of its kind, with a new gas and steam turbine plant. The operator, Linz Strom GmbH wanted integrated documentation, even though the individual facility sections were supplied by different manufacturers. The general contractor, VA Tech Hydro managed this problem using the electrical engineering application ecscad from M+M. The completed documentation consists of approx. 10,000 pages and is available to the maintenance engineers as an intelligent file for quick online search and navigation.

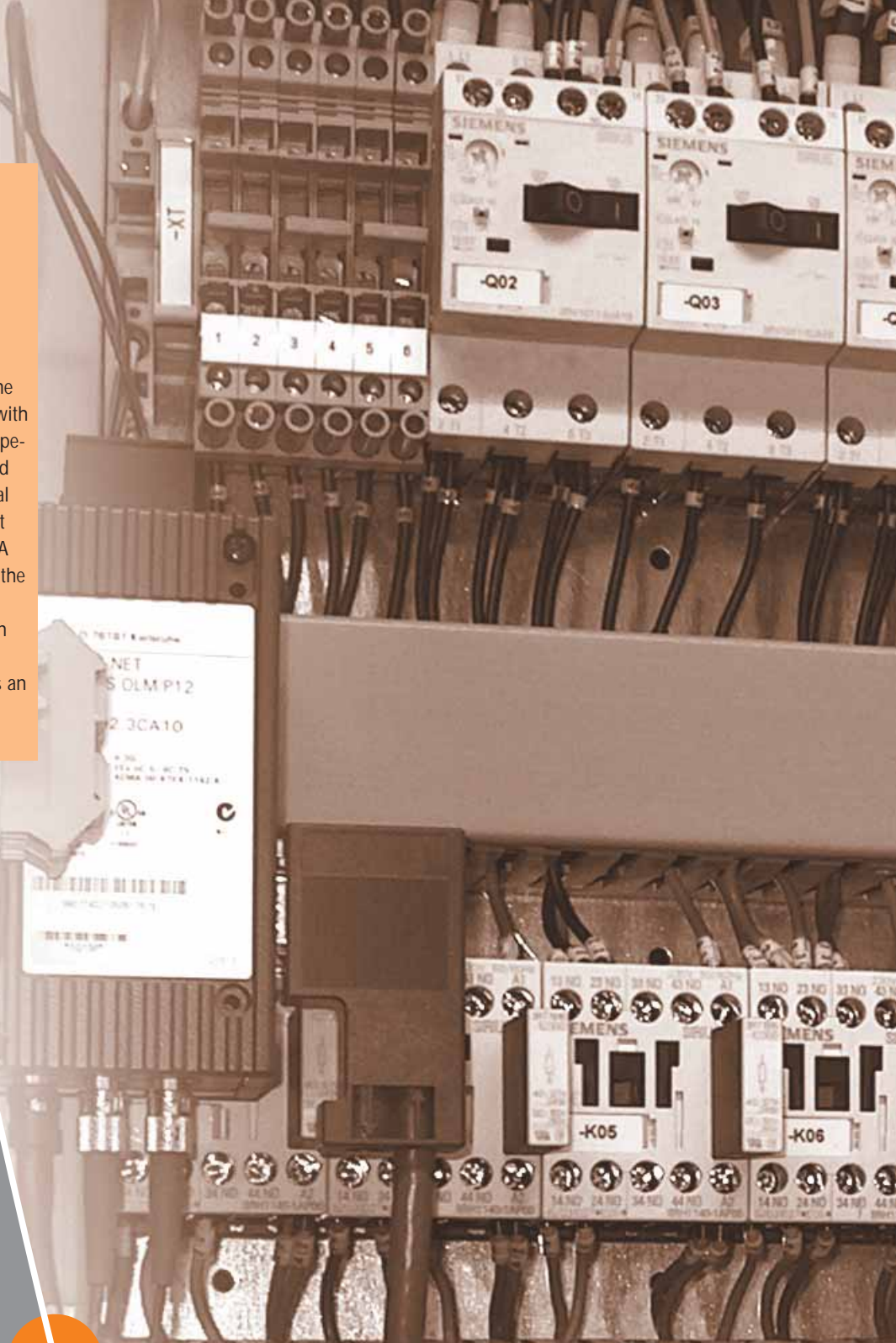

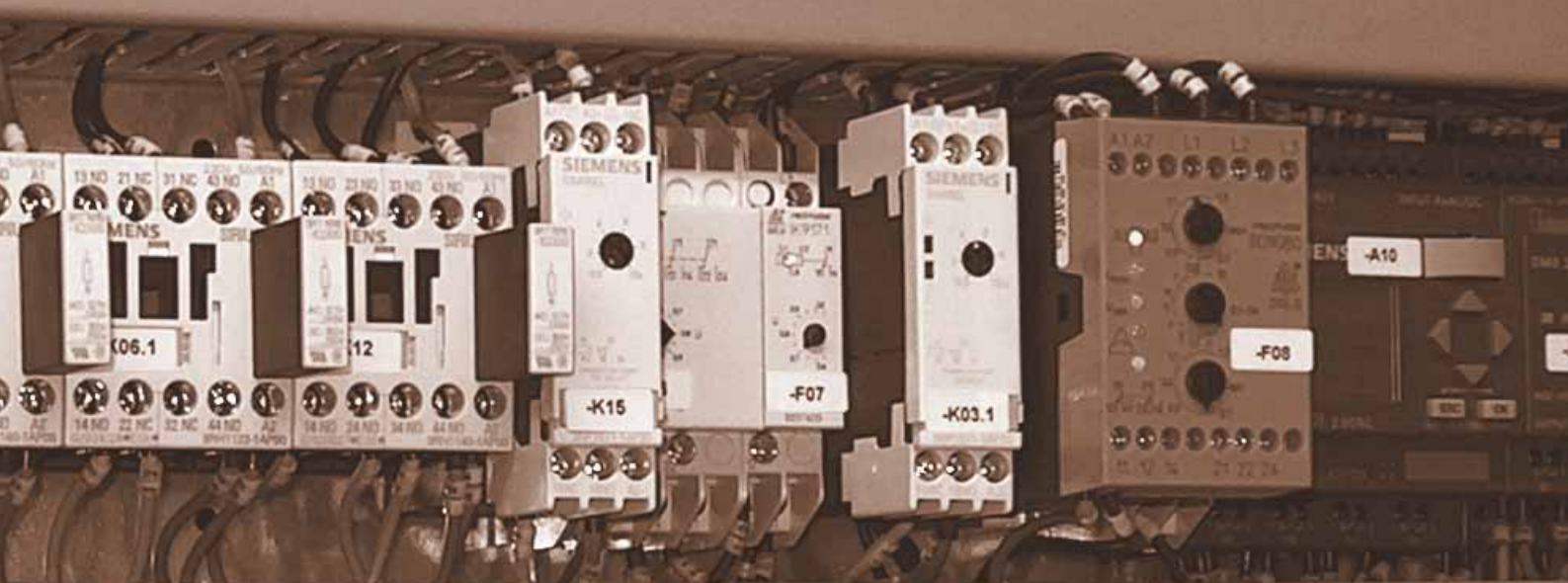
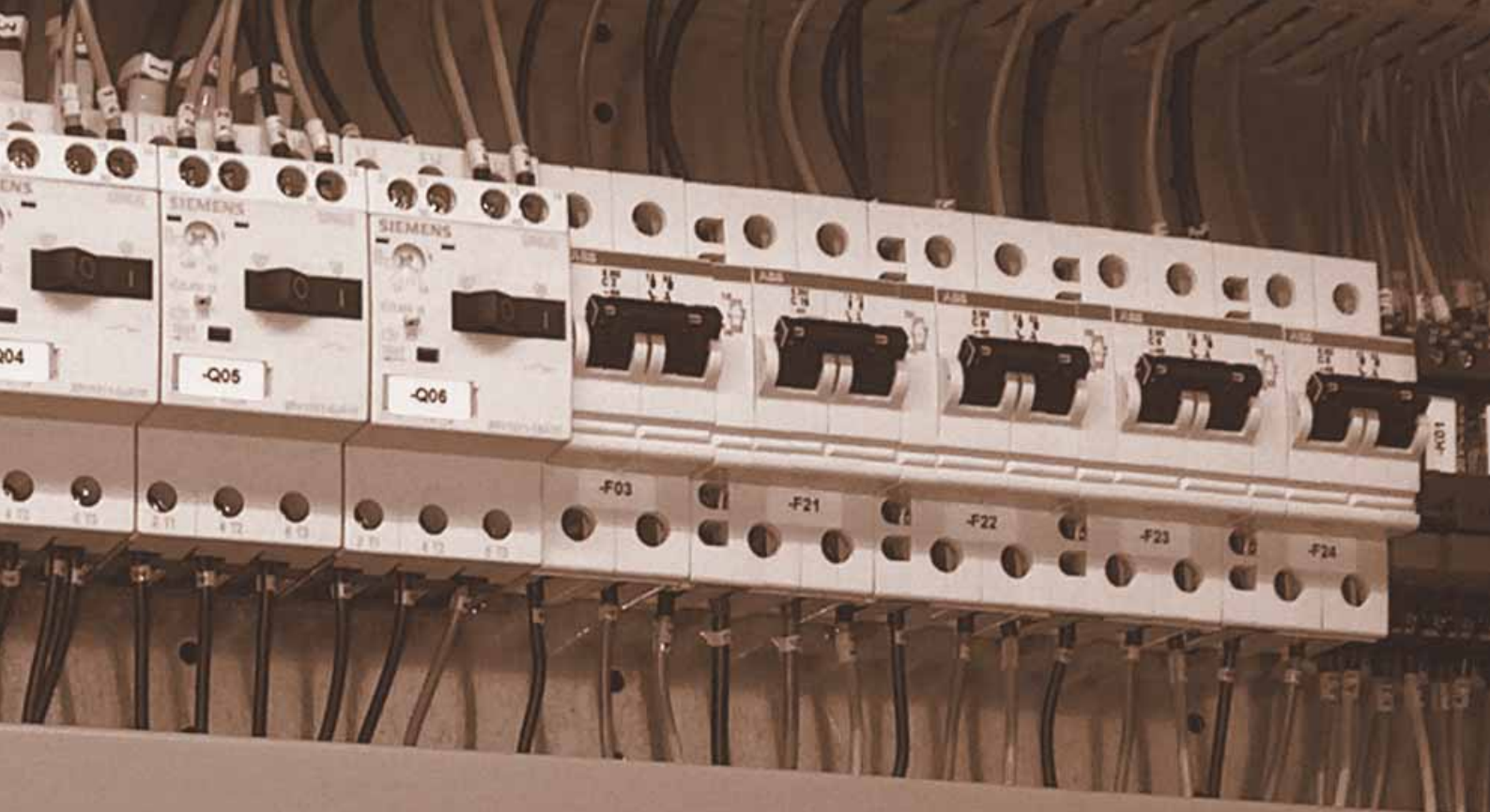

Statement of income						
Amounts in KEUR	Note*	2005		Δ%	2004	
Revenues	1	147,211	100%	+8.7%	135,478	100%
Cost of revenues	2	-104,963	-71.3%	+13%	-92,836	-68.5%
Gross margin		42,248	28.7%	-0.9%	42,642	31.5%
Selling and marketing expenses	3	-25,160	-17.1%	-5.7%	-26,674	-19.7%
General and administrative expenses	4	-8,771	-6.0%	-3.8%	-9,121	-6.7%
Research and development expenses	5	-6,323	-4.3%	-17%	-7,608	-5.6%
Other operating income	6	1,440	1.0%	-7.9%	1,564	1.2%
Operating result EBITA before non-recurring effects		3,434	2.3%	+328%	803	0.6%
Disinvestment profit	7	8,293	5.6%	+182%	2,941	2.2%
Restructuring expenses	8	-1,695	-1.2%	-11%	-1,907	-1.4%
Operating result EBITA before impairment of goodwill		10,032	6.8%	+446%	1,837	1.4%
Impairment of goodwill	9	-300	-0.2%	-90%	-3,000	-2.2%
Operating result EBIT		9,732	6.6%		-1,163	-0.9%
Financial result	10	-2,399	-1.6%	-27%	-3,284	-2.4%
Result before taxes		7,333	5.0%		-4,447	-3.3%
Taxes on income	11	-1,775	-1.2%	-63%	-4,774	-3.5%
Net result		5,558	3.8%		-9,221	-6.8%
thereof attributable to M+M AG shareholders		5,459	3.7%		-9,306	-6.9%
thereof attributable to minority shareholders		99	0.1%		85	0.1%
Net income per share (basic)		0.45			-0.85	
Net Income per share (diluted)	12	0.43			-0.84	
Weighted average shares outstanding in million (basic)		12.053		+10%	10.972	
Weighted average shares outstanding in million (diluted)	12	12.831		+17%	10.972	

* see notes on page 45 - 47

Balance sheet				
Amounts in KEUR	Note*	Dec 31, 2005	Δ%	Dec 31, 2004
Cash and cash equivalents		998	-11%	1,118
Trade accounts receivable	13	23,467	-6%	25,007
Accounts receivable due from related parties		859	+23%	698
Inventories		5,105	+14%	4,491
Prepaid expenses and other current assets	15	4,010	+96%	2,051
Total current assets		34,439 51.9%	+3%	33,365 48.3%
Property, plant and equipment		3,050	-4%	3,161
Intangible assets		384	-55%	851
Goodwill	16	19,459	-7%	20,889
Investments in affiliated companies	17	0	-100%	1,754
Other Investments	18	2,269	-3%	2,348
Deferred taxes	11	6,802	+1%	6,727
Total non current assets		31,964 48.1%	-11%	35,730 51.7%
Total assets		66,403 100%	-4%	69,095 100%
Short term debt and current portion of long term debt	19	14,176	-43%	25,006
Trade accounts payable		22,733	+1%	22,451
Accounts payable due to related parties		4	-99%	377
Advance payments received		39	-84%	241
Accrued expenses	20	3,635	+7%	3,405
Deferred revenues		104	-10%	116
Income tax payable		1,712	+211%	551
Other current liabilities	21	5,209	+125%	2,318
Total current liabilities		47,612 71.7%	-13%	54,465 78.8%
Long term debt, less current portion		1,185	-20%	1,482
Convertible loan	23	1,841	+3%	1,793
Deferred taxes	11	16	-80%	82
Pension accruals	24	607	+71%	355
Other accruals	20	176	+15%	153
Other non current liabilities	25	0	-100%	1,500
Total non current liabilities		3,825 5.8%	-29%	5,365 7.8%
Share capital	26	12,106	+1%	12,030
Capital reserve	27	3,325	+6%	3,125
Other reserves		221		221
Retained earnings / accumulated deficit		-1,284	-81%	-6,743
Minority interest		625	+19%	526
Currency conversion		-27	-124%	106
Total shareholders' equity		14,966 22.5%	+62%	9,265 13.4%
Total liabilities and shareholders' equity		66,403 100%	-4%	69,095 100%

* see notes on page 46 and 48 - 53

 Statement of cash flows			
Amounts in KEUR	Note*	2005	2004
Net result		5,558	-9,221
Depreciation and amortization		1,175	4,804
Other non cash income / expenses		-130	1,732
Increase/decrease in provisions and accruals		505	234
Losses/gains on the disposal of fixed assets		-6,883	-160
Change in net working capital		434	2,770
Net cash provided by operating activities	28	659	159
Sale of subsidiaries		10,369	0
Purchase and sale of property, plant and equipment		-297	-470
Net cash used in (provided by) investing activities		10,072	-470
Proceeds from issuance of share capital		186	2,863
Proceeds from issuance of convertible loan after transaction costs		0	1,892
Proceeds from short or long term borrowings		-11,078	-4,778
Net cash provided by (used in) financing activities		-10,892	-23
Net effect of currency translation in cash and cash equivalents		41	17
Net increase / decrease in cash and cash equivalents		-120	-317
Cash and cash equivalents at beginning of period		1,118	1,435
Cash and cash equivalents at end of period		998	1,118

* see notes on page 53

Changes in consolidated statement of recognized income and expense in shareholders' equity

The statement of recognized income and expense within shareholders' equity includes the Group's net income for the year as well as all other valuation adjustments recorded in the consolidated balance sheet, such as currency conversion differences.

The following table summarizes these fair value adjustments attributable to M+M AG shareholders:

KEUR	2005	2004
Net result	5,558	-9,221
Currency conversion	-133	166
Total recognized income and expense within equity	5,425	-9,055
thereof attributable to M+M AG shareholders	5,326	-9,140
thereof attributable to minority shareholders	99	85

Development of shareholders' equity

Amounts In KEUR	Subscribed Capital	Capital Reserve	Other Reserves	Profit/Loss	Minority interest	Currency exchange	Total Equity
As of Dec 31, 2003	7,012	29,264	221	-21,673	441	-60	15,205
Conversion to 1 EUR par share value	3,960	-3,960					0
Capital increase	1,058	1,852					2,910
Costs of capital increase		-47					-47
Convertible loan		211					211
Costs of convertible loan		-7					-7
Share based payment		48					48
Loss attributable to M+M AG shareholders				-9,306			-9,306
Minority interest change					85		85
Netting of capital reserve		-24,236		24,236			0
Currency conversions						166	166
As of Dec 31, 2004	12,030	3,125	221	-6,743	526	106	9,265
Capital increase	76	110					186
Share based payment		90					90
Income attributable to M+M AG shareholders				5,459			5,459
Minority interest change					99		99
Currency conversions						-133	-133
As of Dec 31, 2005	12,106	3,325	221	-1,284	625	-27	14,966

Segment reporting

The consolidated financial statement comprises a segment report according to IAS 14.

There were no material revenues between the segments. Due to non-materiality the total amount of depreciation on segment assets in accordance with IAS 14.58 is not disclosed.

Within the segment reporting, expenses are reported separately for the segments, allowing for a segment specific report of gross profit as well as operating income before amortization of goodwill. Additionally, the distribution of impairments, income from affiliated companies, fixed assets, investments of the fiscal year and liabilities are separately reported for the segments.

Primary segmentation

The primary segmentation differentiates M+M technology from trading products. The first category contains all proprietary products developed within the M+M group or exclusively licenced by M+M as well as service revenues, the second category contains all trading products sold by the M+M group.

Geographical segmentation

The secondary segment is geographic and distinguishes product and service revenues by the group companies inside and outside Germany.



Primary segmentation

Amounts in KEUR	2005				2004			
	M+M technology		Trading products		M+M technology		Trading products	
Revenues	21,934	15%	125,277	85%	26,733	20%	108,745	80%
Cost of revenues	-2,802	3%	-102,161	97%	-4,308	5%	-88,528	95%
Gross margin	19,132	45%	23,116	55%	22,425	53%	20,217	47%
Selling and marketing expenses	-8,133	32%	-17,027	68%	-9,631	36%	-17,043	64%
General and administrative expenses	-2,653	30%	-6,118	70%	-3,095	34%	-6,026	66%
Research and development expenses	-6,323	100%	0	0%	-7,608	100%	0	0%
Other operating income	661	46%	779	54%	563	36%	1,001	64%
Operating result EBITA before non-recurring effects	2,684	78%	750	22%	2,654		-1,851	
Disinvestment profit	8,293	100%	0	0%	1,500	51%	1,441	49%
Restructuring expenses	-1,111	66%	-584	34%	-1,011	53%	-896	47%
Operating result EBITA before impairment of goodwill	9,866	98%	166	2%	3,143		-1,306	
Impairment of assets	-300	100%	0	0%	-3,440	100%	0	0%
Income from affiliated companies	0	0%	0	0%	193	100%	0	0%
Fixed assets	11,816	47%	13,346	53%	14,278	49%	14,725	51%
thereof affiliated companies	0	0%	0	0%	1,754	100%	0	0%
Investments	167	56%	130	44%	316	67%	154	33%
Liabilities	16,685	32%	34,752	68%	24,415	41%	35,415	59%

Secondary segmentation

Amounts in KEUR	2005				2004			
	Germany		International		Germany		International	
Revenues	39,762	27%	107,449	73%	41,530	31%	93,948	69%
Cost of revenues	-22,201	21%	-82,762	79%	-21,283	23%	-71,553	77%
Gross margin	17,561	42%	24,687	58%	20,247	47%	22,395	53%
Selling and marketing expenses	-10,333	41%	-14,827	59%	-12,346	46%	-14,328	54%
General and administrative expenses	-3,164	36%	-5,607	64%	-3,643	40%	-5,478	60%
Research and development expenses	-6,323	100%	0	0%	-7,608	100%	0	0%
Other operating income	1,118	78%	322	22%	1,055	67%	509	33%
Operating result EBITA before non-recurring effects	-1,141		4,575		-2,295		3,098	
Disinvestment profit	8,293	100%	0	0%	2,941	100%	0	0%
Restructuring expenses	-847	50%	-848	50%	-896	47%	-1,011	53%
Operating result EBITA before impairment of goodwill	6,305	63%	3,727	37%	-250		2,087	
Impairment of assets	-300	100%	0	0%	-3,440	100%	0	0%
Income from affiliated companies	0	0%	0	0%	0	0%	193	100%
Fixed assets	14,738	59%	10,424	41%	18,459	64%	10,544	36%
thereof affiliated companies	0	0%	0	0%	0	0%	1,754	100%
Investments	177	60%	120	40%	408	87%	62	13%
Liabilities	24,895	48%	26,542	52%	36,903	62%	22,927	38%

CAD in practice

Mechanical Engineering

Project: Standardized CAD world for 2D and 3D construction

Customer: Carl Stahl GmbH, Suessen, Germany

Steel cords, ropes, lever and mounting facilities: the product portfolio of Carl Stahl GmbH ranges from special steel cords for medical technology at diameters of less than 1 mm to lever and mounting facilities for heavy loads and facade nets for modern architecture. Both the products and the handling facilities are developed in house.

In order to avoid internal information losses and to make better use of corporate know how, Autodesk's Inventor Professional Series was introduced throughout all production sites.

This standardization was successfully implemented within a few weeks - and all existing old data is accessible by the new system.

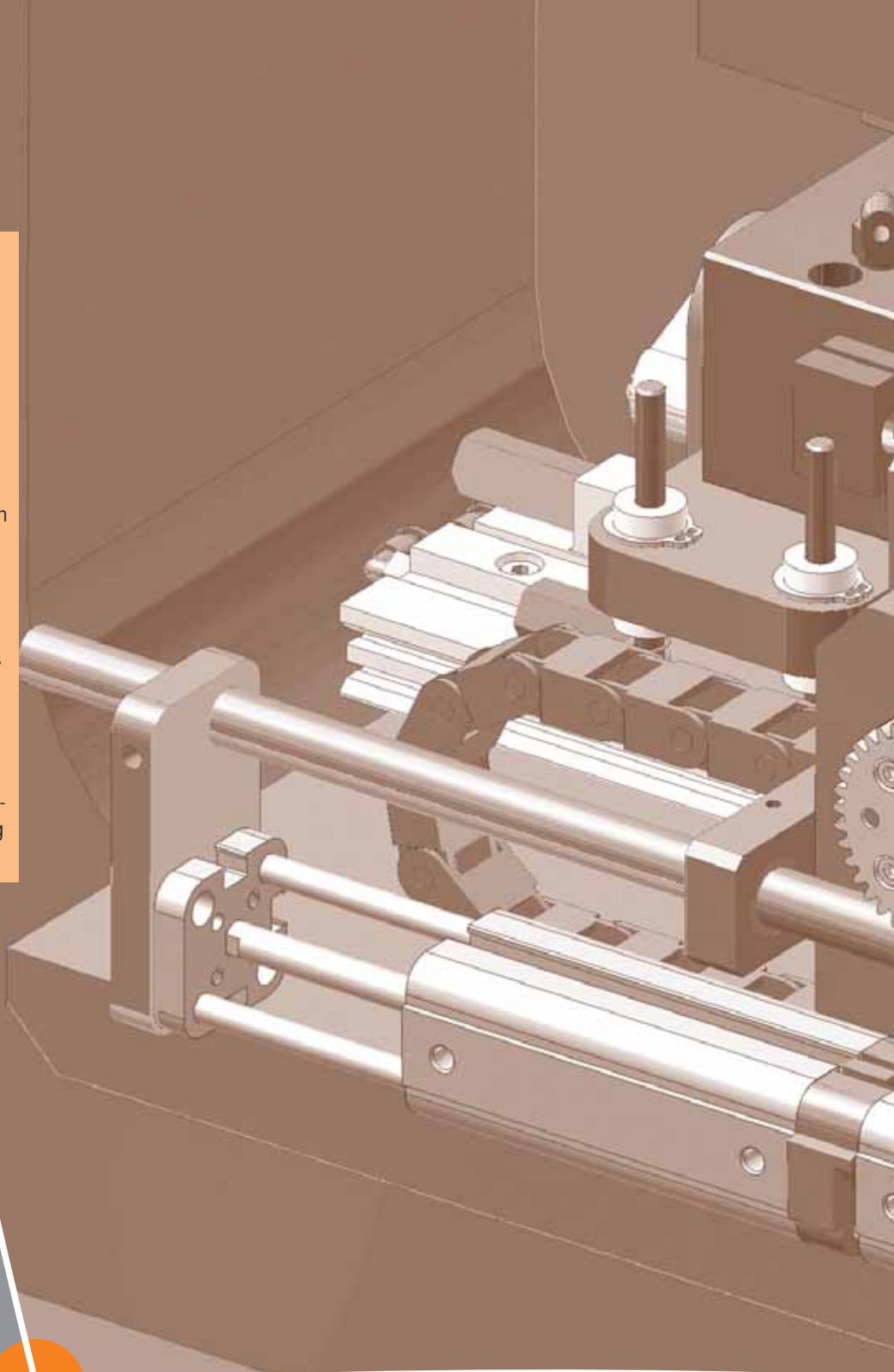

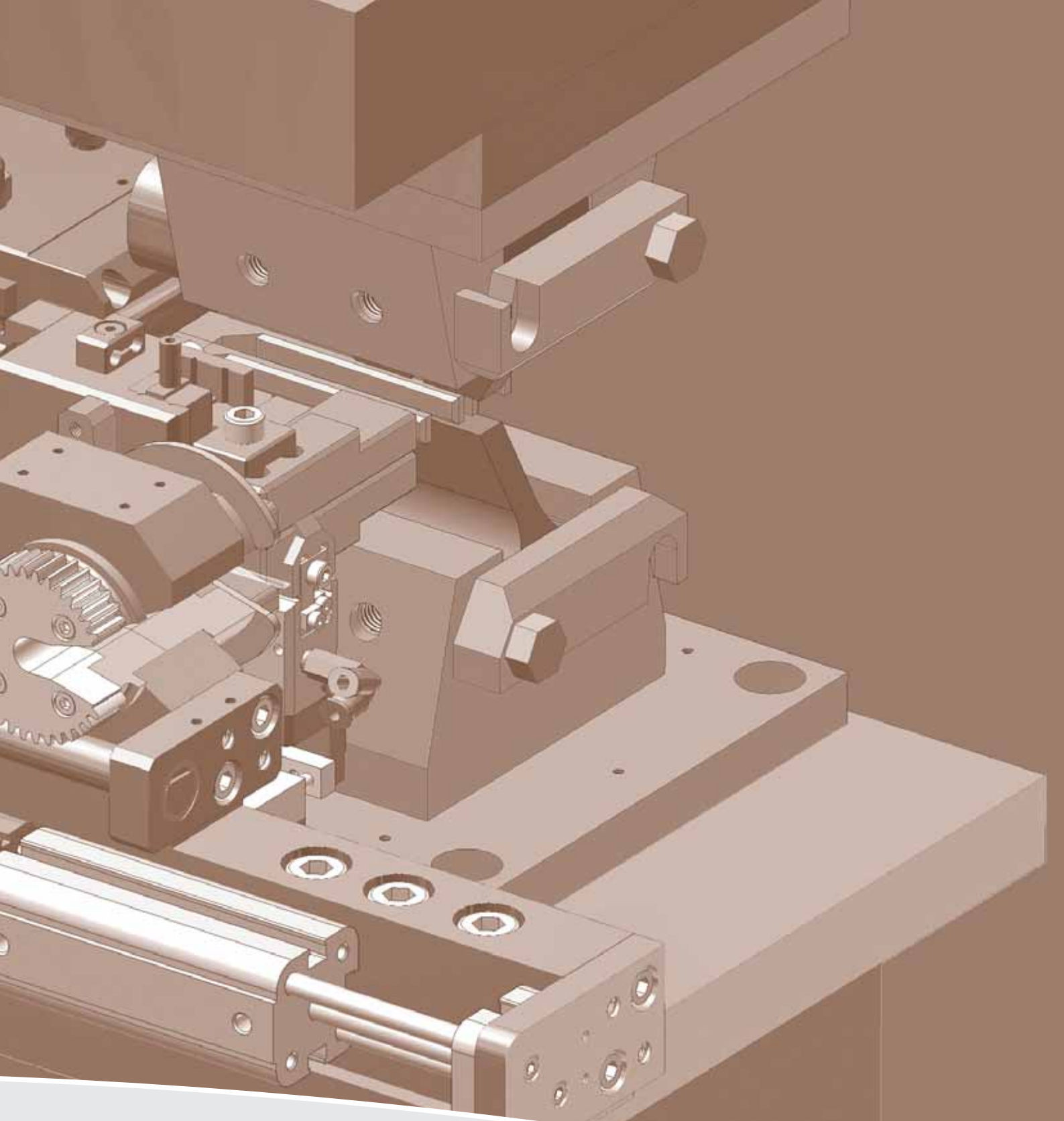

Notes

General remarks

Basis of the group financial statement

The consolidated financial statement of Mensch und Maschine Software AG, Wessling, Germany has been drawn up in compliance with International Financial Reporting Standards (IFRS) according to the specifications as defined in the currently valid guidelines of the International Accounting Standards Board (IASB). All International Financial Reporting Standards (IFRS) and International Accounting Standards (IAS) as well as the interpretations of the International Financial Reporting Interpretations Committee (IFRIC) or the former Standing Interpretations Committee (SIC) which have been in effect at the closing date and accepted by the EU have been considered.

In addition to that, the regulations of Article 315a of the German Commercial Code and §161 of the German Stock Corporation Act have been considered.

In connection with drawing up the group financial statement according to the International Financial Reporting Standards (IFRS), no group financial statement according to the German accounting standards (HGB) was drawn up pursuant to Article 315a of the German Commercial Code.

For the fiscal year 2005, the following IFRS standards have been adopted:

- IAS 1 Presentation of Financial Statements
- IAS 8 Accounting Policies, Changes in Accounting Estimates and Errors
- IAS 16 Property, Plant and Equipment
- IAS 32 Financial Instruments; Disclosure and Presentation
- IAS 39 Financial Instruments; Recognition and Measurement

The IASB issued following Standards and Interpretations for annual periods beginning on or after January 1, 2006:

- IFRS 6 Exploration for and evaluation of mineral resources
- IFRS 7 Financial Instruments; Disclosure and Presentation
- IFRIC 4 Determining whether an arrangement contains a lease
- IFRIC 5 Rights to Interests arising from decommissioning, restoration and environmental rehabilitation funds
- IFRIC 6 Liabilities arising from Participating in a Specific Market - Waste Electrical and Electronic Equipment

These Standards and Interpretations have to be applied for annual periods beginning on or after January 1, 2006. These regulations have not been early adopted by the M+M group.

The effect of the application of these standards can not be estimated exactly, but will probably have immaterial impact on the Group's financial position, results of operations or cash flows.

Valuation methods and accounting policies applied

Consolidated companies and closing date

In addition to the parent company, the consolidated financial statement comprises all directly and indirectly owned domestic and international subsidiaries, at which M+M AG holds directly or indirectly the majority of the voting rights or the control of the economic power, which are included in accordance with the principles of full consolidation.

In addition to the parent company, the companies listed opposite were fully consolidated in the group financial statement of December 31, 2005.

Balance sheet closing date for the subsidiaries included in the group consolidated financial statement is December 31.

❖ M+M group consolidated companies	
Mensch und Maschine Systemhaus GmbH, Wessling	100%
Mensch und Maschine Akademie GmbH, Bad Boll, Germany	100%
Mensch und Maschine Software AG, Riehen (Basel), Switzerland	100%
Mensch und Maschine Software Ges.m.b.H., Salzburg, Austria	100%
Man and Machine S.a.r.l., Bagnolet (Paris), France	100%
Man and Machine Software s.r.l., Vimercate (Mailand), Italy	100%
Man and Machine Software Sp.ZO.O., Lodz, Poland	100%
Man and Machine Ltd., Thame, UK	100%
Man and Machine AB, Sundbyberg (Stockholm), Sweden	100%
Man and Machine Benelux NV, Ternat (Brüssel), Belgium	100%
EUKLID Software GmbH, Wessling, Germany	100%
DATAflor Software Aktiengesellschaft, Goettingen, Germany and 100% shareholdings: DATAflor EDV fuer die gruene Branche GmbH, Goettingen, Germany DATAflor Vertriebs GmbH, Grossbeeren, Germany DATAline Service und Support GmbH, Goettingen, Germany	61,5%
Elektro-CAE-Software GmbH (ECS), Donzdorf, Germany	60%
OPEN MIND Technologies AG, Wessling, Germany and 100% shareholdings: OPEN MIND Software Technologies USA Inc., Southfield/Michigan, USA OPEN MIND Software Technologies PTE Ltd., Singapore OPEN MIND Software Technologies Italia s.r.l., Rho (Mailand), Italy OPEN MIND Software Technologies S.a.r.l., Le Bourget du Lac Cedex, France OPEN MIND Software Technologies UK Limited, Thame, UK	100%

M+M AG bought the minority interest of subsidiary Compass systems GmbH as of February 15, 2005 and merged it on the M+M AG as of February 28, 2005. By March 31, 2005 all assets and liabilities of the merged Compass systems GmbH were sold. This unit, which is not sufficiently material to be presented as a discontinued operation, generated KEUR 571 (PY: 3,616) of sales and KEUR 120 (PY: 575) of operating income and had net assets of KEUR -2,611 (PY: -2,345) at February 28, 2005.

The financial statements of all group companies were drawn up on the basis of common accounting principles. As far as there is an obligation to examine, they are audited by independent auditors and endorsed an unqualified auditing opinion.

Principles of consolidation

The consolidated financial statements include the business of all majority-owned subsidiaries, of which M+M has control according to IAS 27.6, mainly because of a share ownership of more than 50 percent.

The capital consolidation pursuant to IFRS 3.14 is performed using the benchmark method, by offsetting the book values of the shares with the pro rata equity of the subsidiaries included in the group consolidated financial statement at the date of acquisition or as a first-time consolidation. Date of acquisition is the date at which M+M AG takes the effective control over the company. Normally, this is the time at which the majority of the voting rights is acquired.

The differences arising from the consolidation of capital, to the extent that they are assets, are indicated as goodwill under non-current assets. There were no negative differences in the M+M group.

Minority shares are valued at closing time with their share in shareholders equity respective earnings of the year of the particular subsidiary. For M+M, rule IAS 27.36 is applied saying that negative minority shares have to be settled with shareholders equity

and that no minority shares debit or credit shall be applied to group income statement as long as no positive minority share results which, according to IAS 27.33, has to be shown separately within shareholders equity.

Receivables, reserves, liabilities, accruals and deferrals resulting from intra-group transactions are mutually offset. Differences from the consolidation of debt are treated with effect on earnings. Contingent liabilities were consolidated to the required extent. Interim profits and losses resulting from intra-group supply and service trading were likewise eliminated as were investment returns from companies included in the consolidation. Intra-group sales revenues as well as other intra-group earnings were offset by the appropriate expenditures.

With regard to the consolidation measures affecting results, tax deferrals pursuant to IAS 12 were carried out to the extent that the deviation in tax expenditure would conceivably be balanced in future fiscal years. Deferred taxes were not regarded in cases of semi-permanent differences (goodwill). The total amount of deferred taxes from the individual and consolidated financial statements is included in the item income taxes in the statement of income.



Restatement

As required by IFRS, the 2004 consolidated financial statements have been restated to reflect the impact of the adoption of a number of new or revised IFRS statements on January 1, 2005. Note 29 provides a summary of the impact of these and other voluntary changes in financial reporting. As a result of these changes a statement of recognized income and expense separate from the statement of changes in equity has been introduced.

Estimations and assumptions

Drawing up the group financial statement required estimations and assumptions which can impact the amounts of assets, liabilities and financial obligations at closing date as well as returns and expenses in the fiscal year under review. The actual amounts can differ from these estimations and assumptions.

Currency conversion

The annual financial statements of the group's international subsidiaries were converted into EUR in accordance with the principle of functional currency in compliance with IAS 21. This refers to the respective national currency for all companies since these international companies are financially, economically and organizationally independent with respect to their operations.

Accordingly, equity was converted at the historical exchange rate, the other balance sheet items were converted at the exchange rate on closing date, and income and expenditures as well as year-end results were converted using a mean exchange rate for the year. In compliance with IAS 21, differences arising from currency conversion of both capital consolidation and transfer of the annual earnings to the balance sheet at the mean annual exchange rate were treated as having no effect on earnings and are included within equity.

Structure of statement of income and balance sheet

In keeping with the international practice of consolidated financial statements, the report begins with the statement of income (profit and loss), itemized according to the cost-of-sales method. In accordance with IAS 1, the balance sheet is apportioned into current and non-current assets and into current and non-current liabilities. To improve the clarity in the profit and loss statement, the disinvestment profit and restructuring expenses are shown separately. To guarantee the comparability, the previous year was adapted accordingly.

Accounting and valuation methods

Cash and cash equivalents

M+M shows credit balances at banks under cash and cash equivalents. Foreign currency credit balances are converted by exchange rate at closing date.

Property, plant and equipment

Property, plant and equipment is reported at cost of acquisition less regular depreciation. These assets are depreciated over the useful economic life of 3 to 10 years.

Low value items

Low value items are fully written off in the year of purchase.

Intangible assets

Intangible assets are reported at cost of acquisition less regular depreciation. These assets are depreciated over the useful economic life of 3 to 10 years.

Intangible assets, acquired in the context of a business combination, are capitalized at fair value as at the date of acquisition. Following initial recognition, the cost model is applied to the class of intangible assets. The useful lives of these intangible assets are assessed to be either finite or indefinite. Where amortisation is charged on assets with finite lives, this expense is taken to the income statement through various line items.

Intangible assets, excluding development costs, created within the business are not capitalised and expenditure is charged against profits in the year in which the expenditure is incurred.

Intangible assets are tested for impairment annually either individually or at the cash generating unit level. Useful lives are also examined on an annual basis and adjustments, where applicable, are made.

Research costs are expensed as incurred. Development expenditure incurred on an individual project is not carried forward because its future recoverability cannot reasonably be regarded as assured.

Goodwill and impairment

Goodwill on acquisition is initially measured at cost being the excess of the cost of the business combination over the acquirer's interest in the net fair value of the identifiable assets, liabilities and contingent liabilities. Following initial recognition, goodwill is measured at cost less any accumulated impairment losses.

The early adoption of IFRS 3 (business combinations) has resulted in the ceasing of annual goodwill amortisation after January 1, 2004 and to test for impairment annually at the cash generating unit level according to IAS 36 (revised 2004).

In the context of the impairment test, the recoverable amount of the cash generating units is determined by the current value less sales costs or the value in use. The individual subsidiaries of M+M were defined as cash generating units.

The current value reflects the best estimation of the amount, for which an independent third party would acquire the cash generating units as of balance-sheet date; Sale costs are taken off.



The value in use is determined on the basis of DCF methods. To calculate this, cash flow projections are based on financial budgets approved by senior management covering a three-year period. This planning is based on experiences from the past as well as on expectations over the future market development.

The growth rate applied to cash flow projections for the three-year planning period is between 5% and 7.5% p.a. for gross margin and between 2.5% and 5% p.a. for expenses.

The discount rate is determined on the basis of market data and considers credit and market risks. For the cash generating units it amounts to 9.95%.

Where recoverable amount of the cash generating unit is less than the carrying amount, an impairment loss, amounting to the difference is recognized.

Other Investments

Financial assets include shareholdings in other companies. The reported shareholdings are exclusively shareholdings without substantial influence. Consequently, it is not necessary to value them pursuant to IAS 28 (Accounting for Investment in Associates). Pursuant to IAS 27, shares in companies that do not fall in the category group companies and associated companies, are to be valued pursuant to IAS 39 (Financial Instruments). All shareholdings are reported at cost of acquisition the first time they are recorded, corresponding to the fair value of the stated asset. This is the equivalent of cash or cash equivalents. The shareholdings reported within the M+M Group are financial assets available-for-sale pursuant to IAS 39, as none of the other categories under IAS 39 apply. As the financial assets do not have a listed market price on an active market and it is therefore impossible to reliably calculate a fair value, the subsequent valuation is also at cost of acquisition, whereby all shareholdings are checked for signs of depreciation (Impairment Test).

In general, the shareholdings are checked for depreciation by means of valuations which are taken as a basis when the shares in shareholdings are transferred. The transactions invoked for the purposes of valuation take place between third parties outside the Group. In addition, DCF methods and industry-specific multipliers are applied for the impairment testing. Actually twice the sustained annual gross margin is taken as the maximum book value of an investment not causing an impairment.

Inventory

The valuation of the inventory depends on the regulations of IAS 2. This position contains mainly finished goods which are capitalized at costs. If necessary, an inventory valuation adjustment is made due to a reduced usability. All recognizable risks are considered by appropriate adjustments.

Financial Instruments

Financial instruments entail contractual claims on financial assets. According to IAS 32, financial instruments also include primary instruments, such as trade accounts receivable and payable, investments and financial liabilities.

According to IAS 39, financial instruments are categorized as:

- extended loans and receivables
- financial assets at fair value through profit and loss
- available for sale
- held to maturity

Extended loans and receivables are stated at cost less accumulated depreciation and any impairment in value.

The valuation for Investments measured at fair value has changed. A new category has been created, which allows the valuation at fair value through profit and loss.

Investments classified as available-for-sale, are measured at fair value and accounted in consideration of fluctuations between the trading and the settlement day. Gains or losses on these investments are recognized in income.

Investments classified as held-to-maturity, are measured at cost less any impairment in value, and accounted in consideration of fluctuations between the trading and the settlement day.

The liquid assets, trade receivables and payables have such short terms that there is no significant discrepancy between their fair values and carrying amount. The book value of the liabilities complies approximately with the fair value. The fair value is ascertained by discounted cash flow analysis, which is based on current interests for similar loans.

Credit risk arises from the possibility of asset impairment occurring because counterparties cannot meet their obligations in transactions involving financial instruments. Since M+M do not conclude master netting arrangements with our customers, the total of the amounts recognized in assets represent the maximum exposure to credit risk.



Currency risk is the potential decline in value of financial instruments due to exchange rate fluctuations. Exposure to currency risk arises mainly when receivables and payables are dominated in a currency other than the companies' local currencies. Such risks may be naturally hedged due to receivables and payables in the same currency.

Interest rate risks apply mainly to receivables and payables with maturities of over one year. Items with such long maturities are not of material significance on the operating side. Investment and financial obligations are not hedged due to fixed interest rates.

Derivative financial instruments are not used in the M+M group.

Shares in affiliated companies

Participations where M+M AG exercises a relevant influence, usually due to an investment holding between 20 and 50 per cent, are accounted at equity according to IAS 28. With the equity method no assets and liabilities nor proceeds and expenditures are consolidated, but the historical acquisition costs are adjusted annually by the amount of equity change, which corresponds to the capital share of M+M AG. According to IFRS 3, the linear goodwill amortization has ceased.

During the first at equity incorporation of a participation a difference from the initial consolidation is treated according to the principles of a full consolidation.

C-Plan AG, Muri near Bern, Switzerland, in which M+M AG held a 20 per cent investment, was included at equity in the consolidated financial statements. C-Plan has been sold as of June 1, 2005. As of December 31, 2005 no investment is included at equity in the consolidated financial statements.

Deferred tax assets and liabilities

For the deferral of deferred taxes, M+M uses the balance-oriented temporary concept according to IAS 12. Therefore each balance and valuation discrepancy between IFRS and the tax balance is included in the deferral, if the difference dissolves in the lapse of time and has an effect on the taxable base. Additionally, deferred tax assets are capitalized on tax loss carry forwards according to IAS 12 if they can offset with probable future fiscal profits. This assessment is reviewed annually.

Borrowing costs

In accordance with IAS 23, borrowing costs are exclusively charged to expenditure.

Equity costs

According to IAS 32 the costs for the capital increase are offset with the additional paid in capital.

Accruals

Pursuant to IAS 37, accruals are to be reported at the amount resulting from the best estimate of the financial outflow required to meet current obligations as at the balance sheet date. The value stated for other accruals takes into account all identifiable risks based on past experience and where the scope and maturity is uncertain.

Pension accruals

The pension accruals essentially exist at the parent company and refer to a defined benefit plan for the management board. The pension commitment contains a retirement pay, a widow's pension as well as a disablement pension. In the case of pension the payments are made monthly in advance. Pursuant to the Projected Unit Credit Method according to IAS 19 the pension accruals are measured at the present value of the defined benefit liability. The discount rate used is between 4.00 and 4.25 per cent, the estimated return on plan asset is 4.25 to 4.50 per cent and the future changes in remuneration are 1.50 to 2.00 per cent.

Other assets and liabilities

For all identifiable risks of other assets, appropriate allowances are taken.

Liabilities are valued at their repayment value.

Foreign currency receivables and liabilities

In the individual financial statements, receivables and liabilities are translated at the rate on the balance sheet date. Profits and losses from the translation of foreign currency receivables and liabilities are reported in the Statement of Income under other income and expenses. As the income and expenses are not substantial, there are no notes relating to this position.

Principles of revenue recognition

In the M+M group, recognition of revenue occurs at that time when the risk passes to the customer. For service revenues the percentage-of-completion method is applied if the prerequisites of IAS 18 in connection with IAS 11 are met. The work in progress is determined on the basis of the already furnished project hours in comparison to the entire project volume.



Business combinations

IFRS 3 defines company acquisitions if one enterprise, the acquirer, obtaining control over the net assets and operations of another enterprise, the acquiree, whereby control presents the opportunity to govern the financial and business policies of a company so as to obtain benefits from its activities. In the reporting period no acquisitions occurred.

Stock option plans

Mensch und Maschine are offering its members of the Board of Directors and other employees stock options in the form of an option plan relaunched each year. The subscription price per share is the average closing price of the M+M share on the Frankfurt stock exchange on the first 30 trading days after the annual accounts press conference. The subscription right can not be exercised before the waiting period has expired. The waiting period amounts to 2 or 4 years after the stock option offer. The subscription right continues to exist four years after the waiting period has expired. The subscription right can only be exercised in certain exercise periods. It can only be exercised if the stock market price of the M+M share is at least 15% above the strike price in the last 10 consecutive trading days before the respective exercise period.

In 2005, 315,250 new options have been issued and 75,782 options have been converted. In the period 89,612 options have expired. As of December 31, 2005, 907.328 options are outstanding.

The options are converted by means of a capital increase from the contingent capital, so the conversion price leads to an injection of capital on the one hand and a corresponding increase in the number of shares on the other. In the last two lines of the table on the next page, the respective injection of capital for each issue year and overall is listed. The upper line only shows options exercisable as at December 31, 2005, and the lower line reports all outstanding options.

If all 408,998 exercisable options were converted, this would lead to an injection of capital amounting to KEUR 3,711. In terms of the number of shares as at December 31, 2005 amounting to 12,105,782 and the equity as at December 31, 2005 of KEUR 14,966, this would correspond to 3.37% growth in the number of shares and a 24.79% increase in the equity. In terms of the total number of 907,328 outstanding options and an associated injection of capital amounting to KEUR 5,626, the following values are derived: number of shares +7.49% and capital growth +37.59%.

According to IFRS 2 (Share-based Payments) share-based remuneration for employees granted after November 7, 2002 that had not vested on or before January 1, 2005, has to be accounted for as personnel expenditure for accounting years beginning on or after January 1, 2005. The cost of equity-settled transactions with employees is measured by reference to the fair value at the date at which they are granted. Therefore equity-settled transactions occur, when employees receive remuneration in the form of share-based payment transactions, whereby employees render services in exchange for shares or rights over shares. Since it is not possible to measure job performance at fair value, the fair value of the granted shares are used. Thus the costs of this remuneration system are measured by reference to the fair value at the date at which they are granted. The cost of equity-settled transactions is recognized, together with a corresponding increase in equity, over the year in which the performance conditions are fulfilled, ending on the date on which the relevant employees become fully entitled to the award ('vesting date').

M+M AG has adopted IFRS 2 in the fiscal year 2005. The previous year has been adapted accordingly.

Development of stock option rights

Year of issue	1999	2000	2001	2002	2003	2005	Total 99-05
Strike price EUR	15.00	12.47	6.85	6.21	2.45	3.59	
Total number granted	181,800	176,600	226,296	249,268	241,108	315,250	1,390,322
as of Dec 31, 2005							
exercised	-----	-----	-----	-----	75,782	-----	75,782
expired	123,400	72,400	91,996	68,112	46,504	4,800	407,212
exercisable	58,400	104,200	134,300	90,578	21,520	-----	408,998
not yet exercisable total	-----	-----	-----	90,578	97,302	310,450	498,330
Total number outstanding	58,400	104,200	134,300	181,156	118,822	310,450	907,328
Capital increase in KEUR for							
Exercisable options only	876	1,299	920	562	53	0	3,711
All options outstanding	876	1,299	920	1,125	291	1,115	5,626

The development of stock option rights is shown in the above table.

Related parties

In the course of our operating business we source and sell materials, inventories and services from and to a large number of business partners. These include companies with which members of the management board of M+M AG are associated. Werner Schwenkert is also managing director of the M+M customer Follow Me GmbH.

Transactions with these companies are carried out on an arm's length basis. Business with such companies was not material from the viewpoint of M+M AG. The M+M AG was not a party to any transaction of an unusual nature or structure that was material to us or to companies or persons closely associated with us, nor does it intend to be party to such transactions in the future.

M+M's CEO and principal shareholder Adi Drotleff subscribed convertible loans amounting to KEUR 824, and got therefore interests of KEUR 47. Furthermore he granted M+M an interest free shareholder loan amounting to KEUR 1,178 (PY: 1,500) as of December 31, 2005.

KTB Technologie Beteiligungsgesellschaft mbH & Co KG which holds shares of 3.2 per cent as of December 31, 2005, granted M+M loans amounting to KEUR 2,500 and got therefore interests of KEUR 36.

Notes to the statement of income

1. Revenues

This position contains trade sales amounting to KEUR 146,017 (PY: 134,073) and sales of business services amounting to KEUR 1,194 (PY: 1,405).

2. Cost of revenues

This position contains predominantly purchases of standard software products. Raw materials and external services play a very subordinate role.

3. Selling and marketing expenses

This position contains personnel expenses amounting to KEUR 12,676 (PY: 13,863), other operating expenses amounting to KEUR 11,956 (PY: 12,023), and depreciation amounting to KEUR 528 (PY: 788).

4. General and administrative expenses

This position contains personnel expenses amounting to KEUR 3,936 (PY: 3,054), other operating expenses amounting to KEUR 4,671 (PY: 5,821), and depreciation amounting to KEUR 164 (PY: 246).

5. Research and development expenses

This position contains personnel expenses amounting to KEUR 4,979 (PY: 5,883), other operating expenses amounting to KEUR 1,161 (PY: 1,395), and depreciation amounting to KEUR 183 (PY: 330).

6. Other operating income

Other operating income contains the returns from private use of cars and telephones in the amount of KEUR 567 (PY: 499), rents received amounting to KEUR 88 (PY: 169) and other income amounting to KEUR 785 (PY: 896).

7. Disinvestment profit

This position contains the gain on disposal of the merged daughter Compass systems GmbH in the amount of KEUR 6,156 and the shares of C-Plan AG in the amount of KEUR 2,137. These units are not sufficiently material to be presented as a discontinued operation. The prior year contains the profit from the sale of a product line of Euklid amounting to KEUR 1,500 and the profit from the part waiver of a bank loan amounting to KEUR 1,441.

8. Restructuring expenses

This position mainly implies restructuring costs amounting to KEUR 907 (PY: 971) as well as consulting and other costs related to restructuring, amounting to KEUR 788 (PY: 936).

9. Impairment of goodwill

The impairment amounting to KEUR 300 (PY: 3,000) applies to the goodwill of Euklid GmbH.

10. Financial result

KEUR	2005	2004
Interest income	72	78
Interest expense	-2.103	-2.705
Income from affiliated companies	0	193
Income from other investments and participations	95	110
Depreciation on financial assets	0	-440
Foreign currency exchange gains / losses	93	201
Other financial expenses	-556	-721
Financial result	-2.399	-3.284

C-Plan AG, Muri near Bern, Switzerland, was included at equity in the consolidated financial statements. For 2004 the increase of the net book value of C-Plan AG amounted to KEUR 193. The shares of C-Plan have been sold as of June 1, 2005.

The depreciation of financial assets in 2004 contained an extraordinary depreciation on the net book value of the shareholding in CYCO BV, Netherlands amounting to KEUR 440.

The other financial expenditures essentially contain bank charges amounting to KEUR 255 (PY: 350), costs of factoring amounting to KEUR 245 (PY: 235) and costs of the convertible loan amounting to KEUR 0 (PY: 105).

11. Taxes on income

This item encompasses tax payments amounting to KEUR 1,917 (PY: 845), a relief amounting to KEUR 75 (PY: reduction amounting to KEUR 3,732) from further development and revaluation of tax assets in accordance with IAS 12, as well as a surplus of KEUR 67 (PY: reduction of KEUR 14) from deferred tax liabilities.

In total there are realizable tax loss carry forwards amounting to KEUR 28,978 (PY: 32,806). This arises deferred tax assets of KEUR 10,508 (PY: 11,865). The realization of the tax loss carry forward has been proved by planning forecasts and flexible tax models of optimization. Hereby only those tax loss carry forwards are capitalized, which can presumably be used within the following five years, resulting in deferred tax assets with an amount of KEUR 6,179 (PY: 5,927), leading to an addition of KEUR 252 (PY: reduction of KEUR 3,209).

At the moment there are no time restrictions for the utilization of the tax assets in the M+M group.

The temporary differences include deferred tax assets amounting to KEUR 623 (PY: 800) resulting from different valuations of intangible assets, as well as deferred tax liabilities amounting to KEUR 15 (PY: 82). The changes have been booked as tax expenditure or proceeds.

The transition between the expected taxes and the actual tax proceeds are explained by the following reconciliation:

Tax reconciliation		
Amounts in KEUR	2005	2004
Result before income tax	7,333	-4,447
Legal tax rate	37%	37%
Expected tax load (PY: tax proceeds)	-2,713	1,645
Tax rate variances		
Foreign tax rate differential	-207	-315
Deviation of the taxable base from		
Non deductible expenses	-156	-113
Tax free income from investments	0	71
Tax free sale of investments	929	0
Depreciation of a non taxable book value	0	-163
Amortization of goodwill	-111	-1,110
Taxable depreciation of intangible assets	351	459
Valuation of deferred tax assets		
Non execution of deferred tax assets	0	-4,574
Other	132	-674
Actual tax load	-1,775	-4,774
Effective tax rate in %	24.2%	-107.4%

12. Calculation of shares outstanding and earnings per share

In accordance with IAS 33, a weighted average was calculated for shares outstanding. The diluted number of shares does not only include the original subscribed capital shares, but also all option rights from the employee option program which were exercisable at the statement closing date, but which had not yet been exercised.

For the purpose of calculating diluted earnings per share, the profit and loss attributable to ordinary equity holders and the weighted average number of shares outstanding has to be adjusted for the effects of all dilutive potential ordinary shares.

In accordance with IAS 33.33, net result is adjusted for the after tax effect of the interest (in 2004 including transaction costs) of KEUR 78 (PY: 100) recognized for the convertible loan.

	2005	2004
Net result attributable to M+M AG shareholders KEUR	5,459	-9,306
Weighted number of shares	12,052,928	10,971,914
Non diluted earnings per share EUR	0.4529	-0.8482
Diluted net loss KEUR	5,537	-9,206
Diluted shares	12,830,779	10,971,914
diluted earnings per share EUR	0.4315	-0.8390

The weighted average number of shares used for the calculation of diluted earnings per share outstanding in the previous year were without consideration of potential ordinary shares, because they did not lead to a dilution of equity.

Fixed assets register

	Acquisition costs				Accumulated depreciation				Net book value	
	Jan 1, 05	Addition	Disposal	Dec 31, 05	Jan 1, 05	Addition	Disposal	Dec 31, 05	Jan 1, 05	Dec 31, 05
I. Tangible assets	7,430	656	-543	7,543	4,269	629	-405	4,493	3,161	3,050
II. Other intangible assets	3,179	100	-586	2,693	2,328	246	-265	2,309	851	384
III. Goodwill	29,749	5,021	-6,151	28,619	8,860	300	0	9,160	20,889	19,459
IV. Financial assets	5,997	0	-1,833	4,164	1,895	0	0	1,895	4,102	2,269
1. Financial assets	4,118	0	0	4,118	1,895	0	0	1,895	2,223	2,223
2. Affiliated companies	1,754	0	-1,754	0	0	0	0	0	1,754	0
3. Other	125	0	-79	46	0	0	0	0	125	46
V. Deferred taxes	6,727	75	0	6,802	0	0	0	0	6,727	6,802
(all amounts in KEUR)	53,082	5,852	-9,113	49,821	17,352	1,175	-670	17,857	35,730	31,964

Notes to the balance sheet

Assets

Current assets

13. Trade accounts receivable

Trade accounts receivable comprised in the group's individual companies include reasonable adjustments and generally have a remaining term of less than one year.

The receivables are reduced by a specific allowance amounting to KEUR 769 (PY: 559).

14. Inventories

This position predominantly contains purchased goods amounting to KEUR 3,799 (PY: 3,162), software licences amounting to KEUR 1,080 (PY: 1,062) and work in process amounting to KEUR 226 (PY: 267). The inventory is reduced by specific allowance amounting to KEUR 240 (PY: 435).

15. Other current assets

This position primarily comprises tax credits, loans and creditor receivables from pending reimbursements.

Non current assets

The development of the non current assets during fiscal year 2005 is indicated in the fixed assets register.

16. Goodwill

The impairment amounting to KEUR 300 (PY: 3,000) applies to the goodwill of Euklid GmbH.

M+M AG has bought the minority interest of the daughter Compass systems GmbH as of February 15, 2005 and merged on the M+M AG as of February 28, 2005. By March 31, 2005 all assets and liabilities of the merged daughter Compass systems GmbH were sold.

Individual goodwill development during the year under review was as follows:

 Goodwill development			
Amounts in KEUR	Dec 31, 2004	Impairment	Dec 31, 2005
OPEN MIND	7,463		7,463
M+M UK	2,982		2,982
M+M Sweden	2,876		2,876
M+M Switzerland	1,265		1,265
DATAflor	1,135		1,135
M+M Italy	1,116		1,116
ECS	711		711
M+M Akademie	700		700
M+M Poland	474		474
M+M France	333		333
EUKLID	623	-300	323
M+M Austria	81		81
COMPASS	1,130	-1,130	0
Total	20,889	-1,430	19,459

17. Investments in affiliated companies

Since Jan 1, 2003, C-Plan AG, Muri near Bern, Switzerland, was consolidated at equity. In 2004 the increase of the book value was KEUR 193. Intercompany profits and losses herewith have been insignificant. The share in C-Plan has been sold as of June 1, 2005.

18. Other investments

Other investments mainly include strategic shareholdings.

The following investments existed on December 31, 2005:

Investments on Dec 31, 2005		
Amounts in KEUR	in %	Book value
YELLO! AG, Wiesbaden	29.3	427
CTB GmbH & Co KG, Buchholz	19.9	200
SOFISTIK AG, Munich	14.3	896
CYCO BV, Netherlands	7.4	700

M+M is performing current evaluations of the financial assets. For this purposes DCF models as well as industry-specific multipliers, which are multiplied by the shareholding's sustained gross margin are used to verify possible impairments. Actually twice the sustained annual gross margin is taken as the maximum book value of an investment not causing an impairment. According to this valuation scheme, a depreciation amounting to KEUR 440 for CYCO BV, Netherlands has been booked in the prior year.

The maximum loss risk is the amount of the respective net book value plus loans given to shareholdings if applicable, amounting to KEUR 859 (PY: 698) as of Dec 31, 2005.

Liabilities**Current liabilities****19. Short term debt and current portion of long term debt**

This position almost exclusively contains bank loans at principal banks in Germany and abroad in the context of credit line.

They are mainly secured by assignments of a claim, pledging of shares at technology subsidiaries as well as endorsements of members of the executive committee or the management of individual subsidiaries.

20. Accrued expenses

Accruals are calculated by taking all identifiable risks into account and always represent the expected repayment amount. They mainly include personnel and restructuring accruals. The development of the accruals in the reporting period is shown in the table of accrual development.

Table of accrual development

Amounts in KEUR	Dec 31, 2004	Disposal	Addition	Dec 31, 2005
Personnel accruals	1,132	-1,132	1,294	1,294
Outstanding bills	1,017	-1,017	1,215	1,215
Restructuring accruals	146	-146	0	0
Other	1,110	-1,110	1,126	1,126
Total current accruals	3,405	-3,405	3,635	3,635
Personnel accruals	153	0	23	176
Total non-current accruals	153	0	23	176
Total accruals	3,558	-3,405	3,658	3,811

Table of accrual development

In the column disposal, there are no major reversings.

21. Other current liabilities

This position contains an interest free shareholder loan of KEUR 1,178 from CEO and principal shareholder Adi Drotleff, as well as loans of KEUR 2,500 from the KTB Technologie Beteiligungsgesellschaft mbH & Co KG which holds shares of 3.2 per cent as of December 31, 2005. Furthermore this position includes debts from VAT and tax on wages and salaries, outstanding social security costs and deferred income.

Non-current liabilities

22. Long term debt, less current portion

This position contains the long term part of bank loans.

23. Convertible loan

As of July 15, 2004, 348,599 unregistered convertible loans have been issued with a nominal amount of EUR 1.00. The loans were issued at EUR 5.75 each.

The convertible loan has a running time of maximum four years and interest is paid annually with 5.75% of the issuing amount from July 15, 2004 (included) till July 14, 2008 if not paid back or converted. The interest is paid annually due on July 15 of the years 2005 to 2008. The loans are paid back latest July 14, 2008 if not paid back or converted before.

Each loan creditor has the irrevocable right during the conversion window (one month after July 15, 2005, 2006, 2007 and last from June 1 to 30, 2008) to convert each loan held in the nominal amount of EUR 1.00 in 1 (one) ordinary share with a par value of EUR 1.00 of M+M AG. Conversion rights were not exercised in 2005.

M+M's CEO and principal shareholder Adi Drotleff signed convertible loans amounting to KEUR 824.

The market value of the liability component and the equity component was determined as of the date of issuing of the loan. The market value of the liability component, which is contained in non current liabilities, was determined on the basis of a market interest rate of 9.0% for an appropriate straight loan. The remaining value of KEUR 211 (less transaction costs of KEUR 7), which represents the equity component, has been transferred to the capital reserve.

Consequently, the liability component will be measured at cost up to the conversion or maturity of the loan. In the fiscal year fictitious interest expenditures of KEUR 48 (PY: 0) has been allocated to the loan capital. However the equity component measured at the date of issuing of the loan remains unchanged.

24. Pension accruals

The pension accruals essentially exist at the parent company and refer to an defined benefit plan for the management board. The pension commitment contains a retirement pay, a widow's pension as well as a disability pension. The pension accruals are determined according to actuarial principles of the projected unit credit method in accordance with IAS 19.

The pension accruals at the balance sheet date amount to KEUR 607 (PY: 355), of which an amount of KEUR 607 represents the determined cash value of the performance-oriented obligation not financed via funding. The cash value determined as at the balance sheet date of the performance-oriented obligations financed via funds amounts to KEUR 1.777. This figure also corresponds to the fair value of the plan assets as at the balance sheet date. The balance of actuarial profits and losses not yet included as at the balance sheet date amounts to non-reported profit of KEUR 237. The time of service expenditure to be calculated retrospectively and not yet reported in the balance sheet amounts to KEUR 0. The Statement of Income includes income from plan assets amounting to KEUR 72,

interest expenses amounting to KEUR 102 and current time of service expenditure amounting to KEUR 104. The stated expenses and income are included in the general and administrative expenses. In the financial year, pension has been paid in the amount of KEUR 39 to a former director of Euklid GmbH.

The status of the defined benefit obligations is as follows:

KEUR	2005	2004
Benefit obligation at start of year	1,986	1,722
Interest cost	102	96
Service cost	104	51
Benefits paid	-39	-39
Net actuarial gain	231	156
Benefit obligation at year end	2,384	1,986
Plan assets at start of year	1,631	1,445
Employer contributions	-39	-39
Actual return on plan assets	72	167
Net actuarial gain	113	58
Plan assets at year end	1,777	1,631
Net recognized liability	607	355

25. Other non current liabilities

This position contained in 2004 an interest free shareholder loan of KEUR 1,500 from CEO and principal shareholder Adi Drotleff. This loan is now shown in the Other current liabilities due to a short term maturity.

Shareholders' equity**26. Share capital**

The subscribed capital of M+M AG as of Dec 31, 2005 comprised 12,105,782 (PY: 12,030,000) shares, with a calculated stake of EUR 1.00 per share.

In 2005, 75,782 options have been converted.

27. Capital reserve

Following reconciliation shows the development of shares:

KEUR	2005	2004
Capital Reserve as of Jan 1	3,125	29,264
Conversion to 1 EUR per share	0	-3,960
Capital increase	110	1,852
Convertible loan	0	211
Cost of transactions net of tax	0	-54
Netting of capital reserve	0	-24,236
Share based payments	90	48
Capital Reserve as of Dec 31	3,325	3,125

The shareholder meeting at May 19, 2003 has agreed the conditional increase of share capital which serves to grant the members of the Board of Directors and other employees stock options. In 2005, 75,782 options have been converted. The premium amounting to KEUR 110 has been allocated to the capital reserve.

Notes to the cash flow statement**28. Other information on operating activities**

According to IAS 7.31 and 7.35, the following information on operating activities has to be disclosed: the total scope of interest settled in cash was KEUR 2,103 (PY: 2,705), interest received in cash was KEUR 72 (PY: 78). In addition, income taxes of KEUR 1,917 (PY: 845) were settled in cash. The other expenses / income not using cash mainly contains of the change of the deferred taxes amounting to KEUR 142 (PY: 3,746) and in the prior year the gain of a waiver from a bank loan amounting to KEUR 1,441.

29. Restated 2004 Consolidated Financial Statements

M+M has adopted the following new IFRS rules or made other improvements to its financial statements presentation from January 1, 2005 and as required by IFRS reflected these in restated 2004 consolidated financial statements:

IFRS 2 (Share based payments)

IFRS 2 requires the fair value of any equity instruments granted to employees to be recognized as an expense. From January 1, 2005, M+M calculates the fair value of the granted options using the black scholes method. The fair value for options and other share-based compensation are charged to income over the relevant vesting periods, adjusted to reflect actual and expected levels of vesting. As permitted by IFRS 2, M+M has restated its prior-year audited historical consolidated financial statements to reflect the cost of grants awarded only since November 7, 2002. An expense of KEUR 48 was charged to the personnel expenses and added to the capital reserve.

IFRS 3 (Business combinations)

Under IFRS 3, with effect from January 1, 2005, all goodwill is considered to have an indefinite life and is not amortized, but is subject to annual impairment testing. This requirement applies to goodwill separately presented in the Group's balance sheet and to goodwill that is embedded in the equity accounting for associated companies. This new accounting policy was to be applied for transactions consummated after March 31, 2004. For the financial years 2004 and 2005 M+M had no business combinations

 Restated consolidated income statement for the year ended December 31, 2004

Amounts in KEUR	Note	2004 adjusted	Adjust- ment	2004 stated
Revenues		135,478		135,478
Cost of revenues		-92,836		-92,836
Gross margin		42,642		42,642
Selling and marketing expenses		-26,674	-20	-26,654
General and administrative expenses		-9,121	-15	-9,106
Research and development expenses		-7,608	-13	-7,595
Other operating income		1,564		1,564
Operating result EBITA before non-recurring effects	29.1	803	-48	851
Disinvestment profit		2,941		2,941
Restructuring expenses		-1,907		-1,907
Operating result EBITA before impairment of goodwill		1,837		1,885
Impairment of goodwill		-3,000		-3,000
Operating result EBIT		-1,163		-1,115
Financial result		-3,284		-3,284
Result before taxes		-4,447		-4,399
Taxes on income		-4,774		-4,774
Net result before minority interest		-9,221		-9,173
Minority interest	29.2		85	-85
Net result		-9,221		-9,258
thereof attributable to M+M AG shareholders		-9,306		-9,258
thereof attributable to minority shareholders	29.2	85		85
Net income per share (basic)		-0.85		-0.85
Net Income per share (diluted)		-0.84		-0.84
Weighted average shares outstanding in million (basic)		10.972		10.972
Weighted average shares outstanding in million (diluted)		10.972		10.972

29.1: KEUR 48 net reduction due to restatement of expenses from share based payment

29.2: Minority interest is separately shown after net result

IAS 1 (Associated companies, minority interests)

IAS 1 (revised) requires minority interests to be included in the Group's equity in the consolidated balance sheet instead of as a separate category in the balance sheet and it is no longer deducted in arriving at the Group's net result. Therefore the amount attributable to minority interests is taken out of net result and their share in the Group's equity is no longer shown separately. IAS 1 (revised) also requires that the tax related to the result of associated companies is not included in the Group's tax expense. The Group's share in the results of its associated companies is also now included in one income statement line and is calculated after deduction of their respective taxes and minority interests. As a consequence of these changes the results of associated companies were decreased by the tax expense.

Other supplementary information

Other financial obligations and contingent liabilities

The other financial obligations are mainly the result from long term rental and operating lease contracts for the group as a whole. The minimum financial obligation for non discounted rental and lease payments is KEUR 10,373 (PY: 11,051). In the current financial year, rent and leasing payments are contained amounting to KEUR 3,203 (PY: 3,411).

The due dates of payments are as following:

	in KEUR
2006	2,612
2007	1,820
2008	1,224
2009	1,039
2010	948
following years	2,730
Total	10,373

Material leasing contracts mainly apply to office buildings at several locations, SAP software and company cars.

Additionally, there is a contingent liability as of April 1, 2007, from the OPEN MIND AG acquisition towards some of the old shareholders, which will be payable if the M+M share price should never achieve or exceed

a level of EUR 15.25 per share for a period of at least four weeks until April 1, 2007. In this case an additional purchase price payment in cash amounting to the difference of the average M+M share price to EUR 15.25 in the 30 days prior to April 1, 2007, multiplied by 192,716 will be due. So the maximum additional payment (at a theoretical M+M share price of zero) thus would be $15.25 \times 192,716 = \text{KEUR } 2,939$.

Employees

The group's average number of employees (excluding temporary workers and trainees) during the fiscal year was 307 (PY: 355). The personnel expenses amounted to KEUR 21,593 (PY: 22,751).

Management board

The management board of Mensch und Maschine Software AG, Wessling, was comprised of the following gentlemen:

Adi Drotleff, Diplom-Informatiker, Schondorf (CEO)

Peter Baldauf, Diplom-Ingenieur (FH), Wessling (Sales), until Jan 3, 2006

Michael Endres, Diplom-Informatiker (FH), Fürstenfeldbruck (Marketing)

Jens Jansen, Diplom-Ingenieur, MBA München (CIO)

Peter Schuetzenberger, Kaufmann, Landsberg (CFO)

Werner Schwenkert, Diplom-Kaufmann, München (CTO)

Remuneration of management board members FY 2005				
in KEUR	fixed	variable	non cash	Options
Adi Drotleff	146	51	69	9
Peter Baldauf	96	23	23	9
Michael Endres	94	23	26	9
Peter Schuetzenberger	96	12	26	9
Jens Jansen	95	12	30	9
Werner Schwenkert	102	32	15	9

Advisory board

The advisory board of Mensch und Maschine Software AG, Wessling, was comprised of the following gentlemen:

Guenther Speiser, Bankbetriebswirt,
Consultant, Tamm,
Chairman from Jan 1, 2005

Norbert Kopp, Diplom-Oekonom,
Managing Director of KTB mbH & Co KG,
Hannover, Vice Chairman from
March 1, 2005

Thomas Becker, Diplom-Kaufmann,
Tax consultant, Neuss

Manfred Meinzer, Diplom-Ingenieur,
Managing Director of Executive Temporary
Management GmbH, Schwaebisch Gmuend,
Vice-Chairman until Feb 28, 2005

Remuneration of board members

Remuneration for the management board amounted to KEUR 782 (PY 644), of which an amount of KEUR 153 (PY: 0) was variable. Additionally the members got non cash remuneration (e.g. company cars, pension commitments, life insurances) amounting to KEUR 189 (PY: 186). The management board granted share options during the period of KEUR 54 (PY: 0). The Black Scholes model was applied in assessing the fair value of the options.

The pension obligation for the management board amounts to KEUR 1,255 (PY: 877) as of December 31, 2005. The increase is not due to a higher employer's pension commitment, but is resulting because of actuarial effects.

Remuneration for the advisory board totalled KEUR 38 (PY: 19). This was split up into KEUR 20 for the Chairman and KEUR 10 for the member Mr. Becker and KEUR 8 for Mr. Kopp.

Mr. Meinzer received a remuneration in 2005 of KEUR 70 during his advisory board activity according to a consultancy contract from March 2004. The advisory board has given the approval according to § 114 Abs. 1 AktG.

Mr. Speiser received a remuneration in 2005 of KEUR 16 during his advisory board activity according to a consultancy contract from April 2005. The advisory board has given the approval according to § 114 Abs. 1 AktG.

Directors' shareholdings and options

On Dec 31, 2005, the members of the management board owned 6,094,996 shares (PY: 6,096,296) and 307,253 options (PY: 281,253) in Mensch und Maschine Software AG. Stock ownership of the members of the advisory board as of Dec 31, 2005, was 5,000 shares (PY: 0), the option ownership of the members of the advisory board was 0 (PY: 0).

Stock and option ownership of individual members of the boards as per Dec 31, 2005, is shown in the following table:

 Directors' holdings Dec 31, 2005		
<i>Management Board</i>	Shares	Options
Adi Drotleff	5,185,508	172,053
Peter Baldauf	7,944	28,800
Michael Endres	24,000	32,400
Jens Jansen	23,544	26,000
Peter Schuetzenberger	30,000	32,400
Werner Schwenkert	824,000	15,600
<i>Advisory Board</i>		
Guenther Speiser	0	0
Norbert Kopp	5,000	0
Thomas Becker	0	0

Other advisory board memberships of board members

On December 31, 2005, Mr. Becker also served as a member of the advisory board for DATAflor AG, Goettingen.

On December 31, 2005, Mr. Drotleff also served as chairman of the advisory board of DATAflor AG, Goettingen, and further was a member of the advisory board for SOFiSTiK AG, Munich.

On December 31, 2005, Mr. Baldauf was also a member of the advisory board of YELLO! AG, Wiesbaden.

On December 31, 2005, Mr. Kopp also served as a member of the advisory board of KIH Kunersdorf Immobilien Holding AG, Hannover, of Foris AG, Bonn, of WAS World Wide Analytical Systems AG, Uedem, of HNE Technologie AG, Augsburg, as well as ComHouse AG, Wuerzburg.

The remaining board members had no seats on any other advisory boards.

Declaration in accordance to §161 AktG (German Corporate Governance Codex)

The company has published for 2005 the declaration required in accordance with §161 AktG and made it accessible to its shareholders via the internet (www.mum.de).

Declaration in accordance to §285 Nr. 17 HBG

The required disclosure of the accountant fee volume is as follows:

KEUR	2005	2004
Audit	348	512
Tax consulting	78	105
Other	0	10
Total	426	627

The expenses in 2005 include an amount of KEUR 78 belonging to the prior year.

Release date for publishing

The consolidated financial statement of Mensch und Maschine AG was released for publishing on March 20, 2006. Publishing was approved by the advisory board. The date of publishing was March 20, 2006.

Events after balance sheet date

There are no reportable subsequent events after the balance sheet date.

✦ CAD in practice

RoCAD for Building Services

Project: Koenigsbau Arcades in Stuttgart Design of the technical control center

Customer: Engineer's office Scheer, Stuttgart, Germany

Koenigsbau Arcades are among the five largest inner city building projects in Germany. Engineer's office Scheer, a long-standing user of M+M's building services solution RoCAD with 15 seats in several locations, executed the design of the technical control center exclusively in 3D, including the three disciplines of heating, air conditioning and plumbing. Clash detection amongst all disciplines, calculations like quantity schedules, pressure loss and bill of materials are just some of the advantages of the three dimensional design that was used in this project.



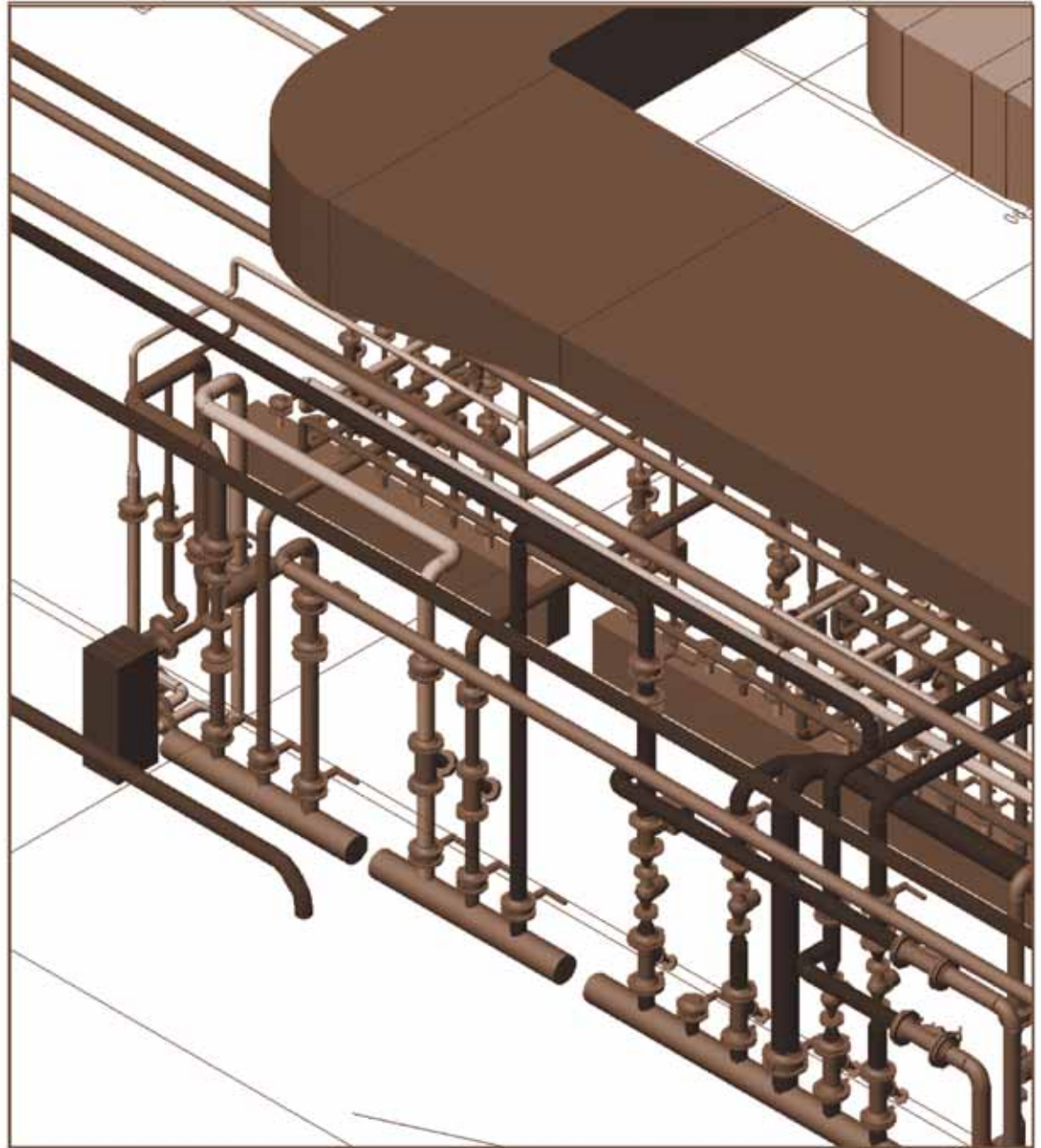
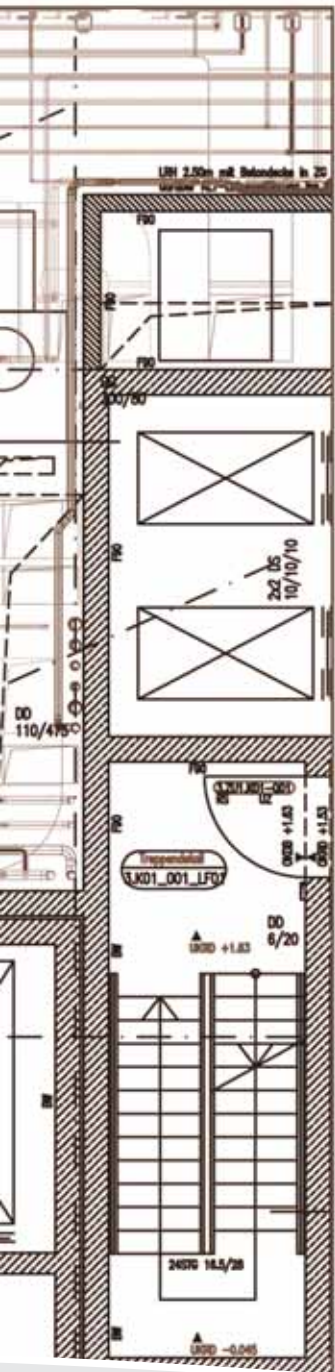

Independent Auditor's Report

"We have audited the consolidated financial statements prepared by Mensch und Maschine Software AG, Wessling, comprising the income statement, balance sheet, cash flow statement, statement of recognized income and expense and the notes to the consolidated financial statements, together with the group management report, for the business year from January 1, 2005 to December 31, 2005. The preparation of the consolidated financial statements and the group management report in accordance with the IFRS, as adopted by the E.U., and the additional requirements of German commercial law pursuant to § (Article) 315a Abs. (paragraph) 1 HGB ("Handelsgesetzbuch": German Commercial Code) are the responsibility of the parent Company's Board of Management. Our responsibility is to express an opinion on the consolidated financial statements and on the group management report based on our audit. We conducted our audit of the consolidated financial statements in accordance with § 317 HGB and German generally accepted standards for the audit of financial statements promulgated by the Institut der Wirtschaftsprüfer (Institute of Public Auditors in Germany) (IDW) and additionally observed the International Standards on Auditing (ISA). Those standards require that we plan and

perform the audit such that misstatements materially affecting the presentation of the net assets, financial position and results of operations in the consolidated financial statements in accordance with the applicable financial reporting framework and in the group management report are detected with reasonable assurance. Knowledge of the business activities and the economic and legal environment of the Group and expectations as to possible misstatements are taken into account in the determination of audit procedures. The effectiveness of the accounting-related internal control system and the evidence supporting the disclosures in the consolidated financial statements and the group management report are examined primarily on a test basis within the framework of the audit. The audit includes assessing the annual financial statements of those entities included in consolidation, the determination of the entities to be included in consolidation, the accounting and consolidation principles used and significant estimates made by the Company's Board of Management, as well as evaluating the overall presentation of the consolidated financial statements and the group management report. We believe that our audit provides a reasonable basis for our opinion.

Our audit has not led to any reservations.

In our opinion based on the findings of our audit the consolidated financial statements comply with the IFRS as adopted by the E.U., the additional requirements of German commercial law pursuant to § 315a Abs. 1 HGB and give a true and fair view of the net assets, financial position and results of operations of the Group in accordance with these requirements. The group management report is consistent with the consolidated financial statements and as a whole provides a suitable view of the Group's position and suitably presents the opportunities and risks of future development."

Stuttgart, March 17, 2006

A W T
AUDIT WIRTSCHAFTS - TREUHAND AG
WIRTSCHAFTSPRÜFUNGSGESELLSCHAFT

Hahn
Wirtschaftsprüfer

Huber
Wirtschaftsprüfer

Advisory Board Report

During the year under review, the Advisory Board of Mensch und Maschine Software AG, Wessling, fulfilled all its obligations as incumbent, pursuant to the corresponding statutes and by-laws, and including the ongoing advice and supervision of the company management.

The Advisory Board was involved in all decisions of principal importance for the company. The strategic direction of the M+M group was closely aligned between the Management and Advisory Board.

The Management Board informed the Advisory Board, orally or in writing, in a regular, timely and extensive manner about all essential matters concerning the short term planning, the actual course of business as well as the financial and earnings situation and in particular with respect to the operating turnaround of the group.

Based on detailed management reports, all business cases significant and essential for the M+M group have been discussed in depth, also concerning the development of the individual subsidiaries. Discrepances in the course of business from the plan have been discussed intensively.

The Advisory Board received reports about the development of the risk management system; existing risks and their provision were explained by the management.

The strategic development of the M+M group was extensively discussed with view to the marketing strategy and the organizational needs, including disinvestments and the intended further alignment of the group to a structure around the European SE.

The development of the company's share and the positioning of the company on the financial market were regular items during the Advisory Board's meetings.

The Advisory Board was informed in detail about events of material importance also in between the regular meetings. The Chairman of the Advisory Board had regular personal contact to the Management Board outside the setting of the official meetings.

During fiscal year 2005, five joint board meetings took place on Jan 18 / March 3 / June 7 / Sept 29 and Dec 21, 2005. All members were present in all meetings. Additionally, there were two telephone conferences at March 15 and 18, 2005.



The annual shareholders's meeting held at June 7, 2005, had to regularly elect all members of the Advisory Board, confirming the members Thomas Becker, Norbert Kopp and Guenther Speiser in their positions.

In the meeting held at June 7, 2005, the Advisory Board elected Mr. Guenther Speiser for Chairman and Mr. Norbert Kopp for Vice-Chairman of the Advisory Board.

The Advisory Board feels committed to the corporate governance principles. Advisory and Management Board explicitly committed to the recommendations for responsible corporate governance fixed in the German Corporate Governance Codex in April 2005 in accordance with §161 AktG. This commitment is permanently accessible for the shareholders on the company's website. Due to the size of the Advisory Board, there were no additional Advisory Board committees. An efficiency test for the activities of the Advisory Board was non explicitly conducted, because improvement processes are constantly discussed and translated into action by the Advisory Board.

The Advisory Board received a declaration of independence from the auditors according to chapter 7.2.1 of the German Corporate Governance Codex.

The annual report of Mensch und Maschine Software AG as of December 31, 2005 including the management report, as well as the group annual report as of December 31, 2005 including the management report for the group was set up by the Management Board and audited by AWT Audit Wirtschafts-Treuhand GmbH Wirtschaftsprüfungsgesellschaft (auditing firm), Stuttgart, and endorsed with an unqualified audit opinion.

The Management Board's set up and the auditing reports from the auditing firm were available to all members of the Advisory Board. The auditor took part in the annual fiscal year report meeting on March 9, 2006, and reported upon all significant results of the audit.

The Advisory Board reviewed the annual report and group annual report, the management and group management report and the management's suggestion for the use of the net income for the year, and finally agrees to the annual report and group annual report, raising no objections after its own review.

In a circular decision at March 19, 2006, the Advisory Board has approved the annual report and group annual report, and agreed the Management's suggestion for the use of the net income for the year.

Management and employees contributed fundamentally and with great commitment to the company's commercial success in a more difficult economic environment during fiscal year 2005.

The Advisory Board would like to take this opportunity to acknowledge its gratitude and appreciation for the exemplary performance demonstrated by all company employees, particularly during the turnaround phase.

Wessling, March 2006
The Advisory Board
Guenther Speiser
Chairman

- **Mensch und Maschine Software AG**
 Argelsrieder Feld 5
 82234 Wessling
 Phone +49 (0) 81 53 / 9 33 - 0
 Telefax +49 (0) 81 53 / 9 33 - 100
 Infoline: 01 80 / 56 86 - 4 61 (EUR 0.12/Min.)
www.mum.de
 Schinkestrasse 8 / 9
 12047 Berlin
 Phone +49 (0) 30 / 6 95 93 20
 Telefax +49 (0) 30 / 6 91 50 18
 Niederkasseler Lohweg 20
 40547 Duesseldorf
 Phone +49 (0) 211 / 5 27 40 - 100
 Telefax +49 (0) 211 / 5 27 40 - 109
 Luisenplatz 1
 65185 Wiesbaden
 Infoline: 01 80 / 56 86 - 4 61 (EUR 0.12/Min.)
 Telefax +49 (0) 6 11 / 37 88 08
- **Mensch und Maschine Austria**
 Alpenstrasse 48A
 5020 Salzburg
 Phone +43 (0) 6 62 / 62 61 50
 Telefax +43 (0) 6 62 / 62 61 50 10
www.mum.at
- **Mensch und Maschine Switzerland**
 Opfikonerstrasse 45
 8304 Wallisellen
 Phone +41 (0) 8 48 / 10 00 01
 Telefax +41 (0) 1 / 883 74 74
www.mum.ch
 Route de saint Légier 7
 1800 Vevey
 Phone +41 (0) 8 48 / 10 00 01
 Telefax +41 (0) 21 / 793 20 39
- **Man and Machine France**
 88, av. du Général de Gaulle
 93170 Bagnolet
 Phone +33 (0)1 / 55 82 45 82
 Telefax +33 (0)1 / 55 82 45 50
www.manandmachine.fr
- **Man and Machine UK**
 Unit 8 Thame 40
 Jane Morbey Road
 Thame, Oxfordshire, OX9 3RR
 Phone +44 (0) 18 44 / 26 18 72
 Telefax +44 (0) 18 44 / 21 67 37
www.manandmachine.co.uk
- **Man and Machine Italy**
 Via Torri Bianche, 7
 20059 Vimercate (MI)
 Phone +39 / 039 / 69 994 1
 Telefax +39 / 039 / 69 994 44
www.mum.it
- **Man and Machine Sweden**
 Prästgårdsgatan 1, 12tr
 172 32 Sundbyberg
 Phone +46(0) 8 / 4 75 42 00
 Telefax +46(0) 8 / 4 75 42 99
www.manandmachine.se
- **Man and Machine Poland**
 Zeromskiego Str. 52
 90-626 Lodz
 Phone +48 (0) 42 / 6 39 23 - 70
 Telefax +48 (0) 42 / 6 39 23 - 79
www.mum.pl
- **Man and Machine Benelux**
 Bergemeersstraat 118
 9300 Aalst
 Phone +32 (0) 53 60 69 69
 Telefax +32 (0) 53 77 29 35
www.manandmachine.be
 Veldbeemdgras 58
 8043 KE ZWOLLE
 Phone +31 (0) 38 / 4 20 42 84
 Telefax +31 (0) 38 / 4 20 42 85

- **DATAflor Software AG**
 August-Spindler-Strasse 20
 37079 Goettingen
 Phone +49 (0) 551 / 5 06 65 - 50
 Telefax +49 (0) 551 / 5 06 65 - 59
www.dataflor.de
 Gustav-Freytag-Strasse 12
 01277 Dresden
 Phone +49 (0) 3 51 / 3 15 66 - 0
 Telefax +49 (0) 3 51 / 3 15 66 - 59
 Poststrasse 13a
 14979 Berlin / Grossbeeren
 Phone +49 (0) 3 37 01 / 5 26 - 0
 Telefax +49 (0) 3 37 01 / 5 26 - 59
 Rheinstrasse 150
 46562 Voerde
 Phone +49 (0) 28 55 / 96 14 72
 Telefax +49 (0) 28 55 / 96 14 76
 Friedrich-Naumann-Strasse 33
 76187 Karlsruhe
 Phone +49 (0) 7 21 / 94 46 8 - 0
 Telefax +49 (0) 7 21 / 94 46 8 - 59
- **ECS GmbH**
 Oeschstrasse 33
 73072 Donzdorf
 Phone +49 (0) 71 62 / 92 93 70
 Telefax +49 (0) 71 62 / 2 42 00
www.ecscad.de
- **Mensch und Maschine Akademie GmbH**
 Badstrasse 62
 73087 Bad Boll
 Phone +49 (0) 71 64 / 9 31 - 01
 Telefax +49 (0) 71 64 / 9 31 - 299
www.mumakademie.de
- **OPEN MIND Technologies AG**
 Argelsrieder Feld 5
 82234 Wessling
 Phone +49 (0) 81 53 / 93 35 00
 Telefax +49 (0) 81 53 / 93 35 01
www.openmind-tech.com
 Carl-Zeiss-Strasse 17
 73230 Kirchheim/Teck
 Phone +49 (0) 70 21 / 95 95 05
 Telefax +49 (0) 70 21 / 95 95 04
 Niederkasseler Lohweg 20
 40547 Duesseldorf
 Phone +49 (0) 211 / 5 27 40 - 300
 Telefax +49 (0) 211 / 5 27 40 - 309
 Blumenstrasse 6
 74358 Pleidelsheim
 Phone +49 (0) 71 44 / 88 67 0
 Telefax +49 (0) 71 44 / 88 67 15
- **OPEN MIND Technologies UK Ltd.**
 30A Upper High Street
 Thame
 Oxon, OX9 3EX
 Phone +44 (0) 1844 / 26 37 46
 Telefax +44 (0) 1844 / 21 16 61
www.openmind-tech.com
- **OPEN MIND Technologies Italia S.r.l.**
 Via Pomè 14
 20017 Rho (MI)
 Phone +39 / 02 / 93 16 25 03
 Telefax +39 / 02 / 93 18 44 29
www.openmind-tech.com
- **OPEN MIND Software Technologies S.a.r.l.**
 Savoie Technolac Bp 325
 73377 Le Bourget du Lac Cedex
 Phone +33 (0)4 / 79 26 46 22
 Telefax +33 (0)4 / 79 26 46 24
www.openmind-tech.com
- **OPEN MIND Software Technologies USA, Inc.**
 70 Walnut Street
 Wellesley Hills, MA 02481
 Phone +1 (781) 239 80 95
 Telefax +1 (270) 912 58 22
www.openmind-tech.com
 39111 W.Six Mile Rd.
 Livonia Detroit, Michigan 48152
 Phone +1 (734) 779 16 25
 Telefax +1 (734) 779 16 26
- **OPEN MIND Technologies Asia Pacific Pte Ltd.**
 10 Ubi Crescent # 05-22, Ubi Techpark
 Singapore 408564
 Phone +65 67 42 95 56
 Telefax +65 67 42 95 26
www.openmind-tech.com
- **OPEN MIND Software Technologies Japan Inc.**
 KS Building 1006, 1-31-11, Kichijojihoncho
 Musashino-shi, Tokyo 180-0004
 Phone +81 422 23 - 53 05
 Telefax +81 422 23 - 53 05
www.openmind-tech.com

Investor contact	
Contact person	Michael Endres
Phone	+49(0)8153 / 933 - 261
Telefax	+49(0)8153 / 933 - 104
E-Mail	investor-relations@mum.de
Internet	www.mum.de/investor



CAD in practice: Railway maintenance and operation

Project: Renovation and modernization of locomotives and wagons

Customer: Golden Pass® Montreux - Oberland Bernois, MOB, Switzerland

The Golden Pass trains of Montreux-Berner Oberland-Bahn (MOB) operate on attractive scenic routes through the alps. Frequently, the passengers travel in historic wagons, technically upgraded to state of the art and supplied with large panoramic windows. For the modification of these trains, Autodesk Inventor was introduced, enabling e.g. the development of a complex pneumatic brake system within just three days - including the simulation of brake block wear and collision tests in the linkage of the brake system.

mensch  **maschine**
CAD as CAD can

Mensch und Maschine
Software AG
Argelsrieder Feld 5
D-82234 Wessling

Phone +49 (0) 81 53 / 9 33 - 0
Fax +49 (0) 81 53 / 9 33 - 100
www.mum.de

